

Nilfisk GM 80CR

INSTRUCTIONS FOR USE & PARTS LIST



Table of Contents

Important Safety Instructions	2
Warranty	3
Using the Machine	4
Installing Paper Bag	
Accessories	
Emptying	5
Disposal	5
Maintenance/Filter Replacement	5
Troubleshooting	6
Loss of Power	
Loss of Suction	
Parts Explosions	7
Accessories	9
Technical Specifications	13
Contact Information	13

For Instructions for Use on ULPA filter installation, please refer to the addendum titled, “ABSOLUTE FILTERS – End User Information.”

IMPORTANT SAFETY INSTRUCTIONS

PLEASE READ THESE INSTRUCTIONS COMPLETELY BEFORE USING THE MACHINE. DEPENDING ON LOCAL REGULATIONS AND THE COMPOSITION OF THE MATERIALS YOU HAVE COLLECTED, THERE MAY BE REQUIREMENTS FOR SPECIAL HANDLING AND DISPOSAL OF THE COLLECTED DEBRIS. CONSULT YOUR LOCAL OCCUPATIONAL SAFETY AND HEALTH ADMINISTRATION (OSHA) AND ENVIRONMENTAL PROTECTION AGENCY (EPA) OFFICIALS FOR DETAILS.

CAUTION: This Nilfisk vacuum cleaner or any other vacuum cleaner is not to be used in explosion-hazardous areas, as serious injury could result.

Under no circumstances may this cleaner safely be used for the collection of hazardous or toxic materials unless equipped with a special HEPA (High Efficiency Particulate Air) or ULPA (Ultra Low Penetration Air) filter and bag which have been installed according to written instructions from Nilfisk-Advance.

ATTENTION EMPLOYER: Please ensure these Instructions for Use are made available and understood by your employees or any other persons who may use this equipment.

To list all toxic and hazardous materials would be beyond the scope of these Instructions. It is the Employer's responsibility to identify, for Employees' and others' information, hazardous or toxic materials which may be collected by this equipment.

Your new Nilfisk industrial vacuum cleaner is a precision-engineered instrument designed for exceptionally fine filtration. Ordinary vacuum cleaners do not have HEPA filters, and cannot be safely used for hazardous dust collection. This Nilfisk machine is safe to use with fine powders or hazardous materials, as long as certain precautions are taken. Proper care of this cleaner is essential to the maintenance of its ultrafine filtering capabilities.

BEFORE USE: DO NOT ATTEMPT TO OPERATE THIS CLEANER UNTIL YOU HAVE INSTALLED ITS VARIOUS COMPONENTS ACCORDING TO THE FOLLOWING INSTRUCTIONS:

WARRANTY

The Nilfisk companies warrant that Nilfisk equipment will be free of defects in workmanship or material for a period of two years from the date of delivery. Should any failure to conform to this warranty appear, the Nilfisk companies shall upon notification within such time period, correct such non-conformity, at its option, either by repairing any defective part or parts, or by replacing a part or parts provided that the equipment is returned to an authorized Nilfisk service facility. In all cases freight both ways will be at the expense of the customer. Equipment shall not be returned without advance notice to, and consent of the Nilfisk companies.

EXCEPT AS SPECIFICALLY SET FORTH HEREIN, THE NILFISK COMPANIES MAKE NO WARRANTIES, EITHER EXPRESSED OR IMPLIED AS TO ANY MATTER WHATSOEVER, INCLUDING WITHOUT LIMITATION ANY AND ALL WARRANTIES OF MERCHANTABILITY, FITNESS FOR PURPOSE, OR OTHER WARRANTIES, ALL OF WHICH ARE EXPRESSLY DISCLAIMED AND EXCLUDED. NEITHER PARTY SHALL BE LIABLE TO THE OTHER FOR SPECIAL, INDIRECT, INCIDENTAL OR CONSEQUENTIAL DAMAGES, INCLUDING BUT NOT LIMITED TO LOSS OF PRODUCTION, LOSS OF TIME, LOSS OF PROFITS OR OTHER SIMILAR INDIRECT LOSSES WHICH MIGHT OCCUR AS A RESULT OF DEFECTS, PARTIAL OR TOTAL FAILURE OF THE PRODUCT TO PERFORM AS SPECIFIED.

Correction of non-conformities or defects in the manner and for the period of time provided above, shall constitute fulfillment of all liabilities of the Nilfisk companies to the customer, whether based on contract, negligence or otherwise with respect to, or arising out of such equipment. The remedies set forth herein are exclusive, and the liability of the Nilfisk companies with respect to this sale or anything done in connection therewith, whether in contract, in tort, under any warranty, or otherwise, shall not except as expressly provided herein, exceed the price of the equipment or part on which such liability is based.

The warranty does not cover repairs due to normal wear and tear, accident, neglect, misuse or abuse, incorrect installation or use other than as described in the instruction booklet. Breaks in hoses and cables are not covered. This warranty is rendered void if the motor number plate is removed or defaced or if repairs are made or attempted by persons not authorized by the Nilfisk companies.



Photo 1

USING THE MACHINE

The GM 80CR has been packaged in plastic to protect it during shipment, and all critical filters are installed at the factory.

Starting and stopping: Press the gray button on the upper front portion of the vacuum (photo 1).

Correct use of the machine: This machine is not a wet/dry vacuum. It is intended for dry collection only. Do not use this vacuum to pick up liquids, or any wet materials.



Photo 2



Photo 3

Installing the Polyliner and Paper Bag

Twist and release the two container clips located on the body of the container, front and back. Lift off the top. Open the polyliner and place in the bottom of the container with its walls flush against the container sides and lipped under the container inlet (photo 2). The excess length of polyliner is draped over the top of the container and down the outside then rolled at the end to permit the container clips to close.

Install a paper bag inside the polyliner according to the illustrations printed on the paper bag itself (photo 3). Replace the top container and fasten the two clips.

Note: Polyliners are optional. If you choose not to use a polyliner, follow the instructions to install the paper bag.

Accessories

The GM 80CR offers a package of standard accessories that can be connected in the following manner. Affix the conductive plastic hose to the vacuum by inserting it into the orifice on the lower container. Once it is inserted, rotate the inlet coupler a quarter turn to lock it into place. Either of the straight 22 inch stainless steel wands can be fitted to the other end of the hose by snapping it in place. You can connect the floor nozzle or the upholstery nozzle to the end of the straight wand. The GM 80CR kit includes a conductive crevice nozzle and conductive 3 inch round brush, which can be attached to either the wands or to the curved steel tube at the end of the conductive plastic hose. A tool caddy (#01720600) is also included to provide easy onboard storage of accessories.

EMPTYING:

IF THIS VACUUM CLEANER IS USED TO COLLECT HAZARDOUS MATERIAL, DO NOT ATTEMPT TO OPEN OR EMPTY ITS CONTENTS WITHOUT PERSONAL PROTECTIVE CLOTHING AND RESPIRATORY PROTECTION.



Photo 4

To empty the container and its contents, first turn off the motor. Allow the cleaner to sit undisturbed for at least thirty (30) seconds. Then twist and release the container clips. Once the seal is broken, turn on the motor again. This will prevent ultrafine particles which are still suspended in the air inside the container from escaping into the work place. Lift off the container top. Remove the polyliner and paper bag within it (photo 4). Then seal off the polyliner with the paper bag inside and install a new polyliner and paper bag according to step 2, Machine Setup.

DISPOSAL:

Depending on local regulations, and the composition of the material you have collected, there can be a requirement for special handling and labeling of the filled and sealed plastic bags. Consult your local Occupational Safety and Health Administration (OSHA) and Environmental Protection Agency (EPA) official for details.

MAINTENANCE

Routine Maintenance:

To ensure maximum performance of your Nilfisk vacuum cleaner, be sure to check your main filter regularly, possibly each time you change the paper bag. Your filter may need to be shaken to remove caked dust from time to time.

Filter Replacement:

To ensure that your Nilfisk vacuum cleaner delivers the years of trouble-free operation for which it was designed, it is necessary to check and replace filters regularly.

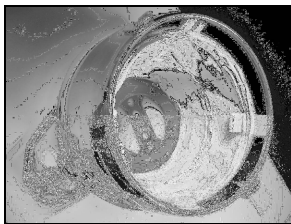

Photo 5

1. Main Filter: The large napped cotton bag which is semi-permanently mounted inside the container (photo 5) will not require frequent replacement. The main filter must be replaced when the cleaner no longer develops powerful suction, yet bags are not full and other filter components are not clogged. Extend main filter service life by frequent changes of disposable polyliners and paper bags.

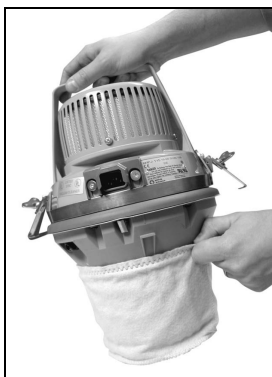

Photo 6

2. Microfilter: This small polyester sock (photo 6), which fits over the motor bottom will require periodic inspection. Dust will discolor the microfilter. Change the microfilter as soon as any discoloration is easily noticeable. Do not shake this microfilter since this can cause liberation of potentially harmful microscopic dust into the air. Carefully remove and discard with collected debris in the sealable poly bag. If equipped with a Gore-Tex microfilter, the same rules for periodic inspection and disposal apply. The Gore-Tex microfilter must be changed when any abrasions, damage or heavy discoloration is noticed on the surface of the filter. The Gore-Tex microfilter is held in place by a clamp on the vacuum.



Photo 7

3. **ULPA Exhaust Filter:** The ULPA (Ultra Low Penetration Air) filter ensures that 99.999 percent of all ultrafine particles, toxic and nuisance, are retained – down to and including 0.12 microns. The ULPA filter cartridge is mounted on the top of the motor, outside the container (photo 7). If the main filter and microfilter are properly maintained, the glass fiber element in the exhaust filter should perform satisfactorily for a minimum of one year. It cannot be renewed or restored. Exact life will depend upon frequency of use and amount and type of material collected. Normally four changes of microfilter equal one change of the ULPA filter. Remove the protective metal casing and replace the pleated glass fiber cartridge according to the accompanying instructions. Cartridges must be replaced more frequently if the cleaner has had unusually heavy use, or if the various pre-filters have been neglected.

CAUTION: Use only genuine Nilfisk replacement filter components. The use of substitute components could pose a grave risk of personal exposure, and will cause all equipment warranties to be void.

TROUBLESHOOTING

Loss of Power:

1. Make sure the power cord is properly fastened to the motor head, and it is properly plugged into the socket.
2. Be sure the electrical circuit has not blown a fuse.
3. If the circuit is functioning properly, but there is still no power, contact Nilfisk-Advance America's Customer Service Department at (800) 645-3475, extension 2.

Loss of Suction:

If the GM 80 loses suction power during operation, there may be several reasons, the most likely of which is a full container. Suction loss is gradual as the container fills with debris. Check to see if there is any blockage or restriction in hose. Next, check the condition of the main filter and microfilter (refer to photos) and determine whether there is an excessive loading of debris. If there is overloading in the main filter, you can shake it. If the microfilter is loaded, it needs to be replaced. Call our Customer Service Department at (800) 645-3475, extension 2 to order replacement filters.

If all fails, call our Customer Service Department.

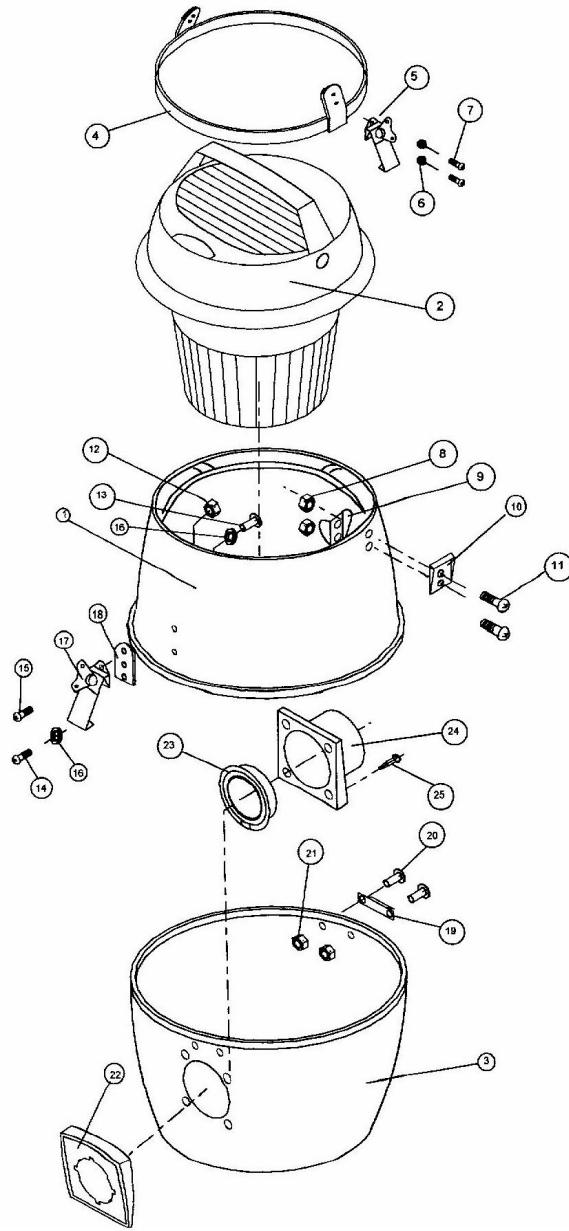

GM 80CR Container Assembly

No.	Item No.	Description	Qty.
1	115446-11	UPPER CONTAINER W/ COTTON FILTER	1
2	121103-29	MOTOR COMPLETE	1
3	115447-10	LOWER CONTAINER	1
4	017091-00	MOTOR HOLD DOWN RING	1
5	017092-11	LATCH	2
6	805521-00	WASHER	4
7	815406-00	SCREW, 4MM X 5MM	4
8	705285-10	NUT, 4MM ESN	4
9	712366-00	SPRING CUP	2
10	017093-16	KEEPER	2
11	815407-00	SCREW, 4MM X 10MM	4
12	705265-10	NUT, 4MM ESN	2
13	815405-00	SCREW, 4MM X 5MM	2
14	815406-00	SCREW, 4MM X 5MM	2
15	815407-00	SCREW, 4MM X 10MM	2
16	805521-00	WASHER	4
17	017092-11	LATCH	2
18	017094-10	ADAPTER	2
19	017093-05	KEEPER	2
20	815412-00	SCREW, 4MM X 6MM	4
21	705265-10	NUT, 4MM ESN	4
22	815419-00	RING	1
23	815418-00	GASKET	1
24	815417-00	SOCKET	1
25	814312-00	SCREW	4
26	017096-00	LATCH KIT (Includes item numbers 4, 5, 6, 7, 8, 9,10, 11, 12, 13, 14, 15, 16, 17, 18)	

ULPA Filter Kit (017204-XX)

No.	Item No.	Description
1	217377-01	HANDLE
2	717376-00	FILTER COVER
3	017247-01	HOLD DOWN PAD
4	017009-01	SEAL, FOAM, ULPA
5	813950-00	SCREW
6	821070-00	FILTER BASE
7	017010-05	SEAL, FOAM, BOTTOM
8	01737631	ULPA FILTER CARTRIDGE (Includes item numbers 3, 4, 7)

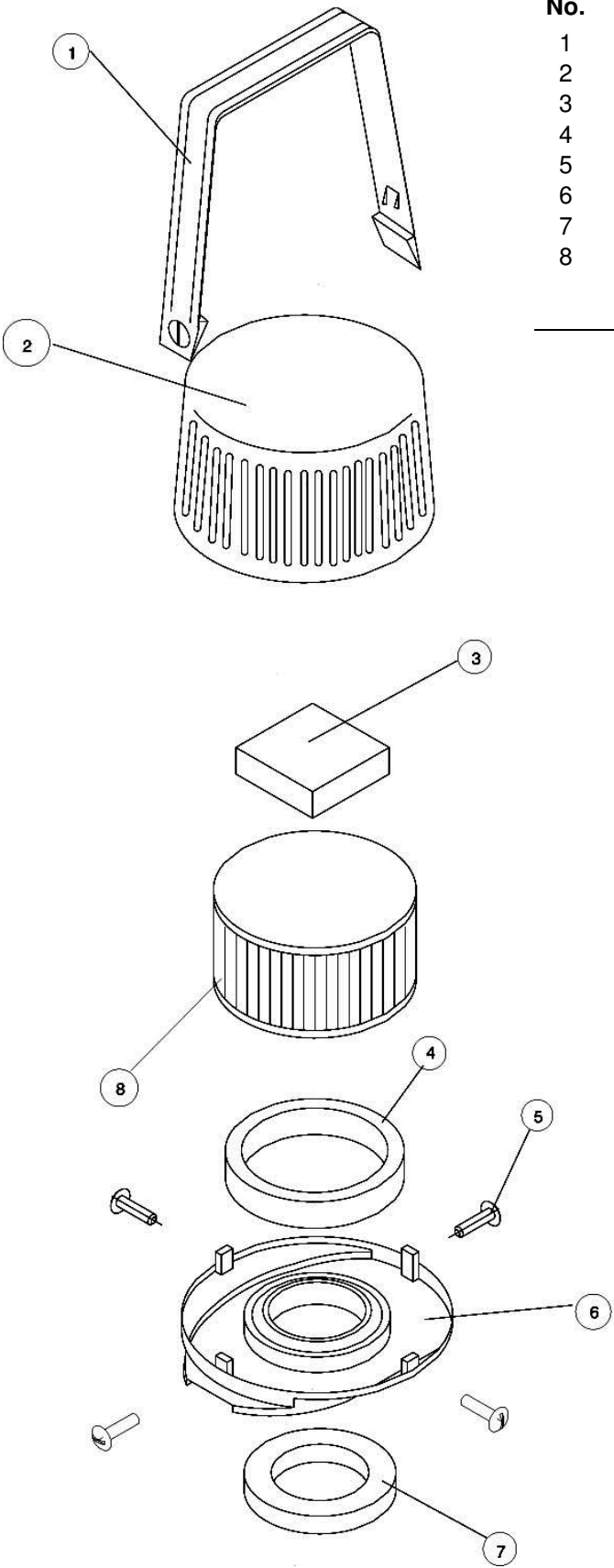

STANDARD ACCESSORIES

No.	Item No.	Description
1	01709041	CONDUCTIVE CREVICE NOZZLE
2	01709036	CONDUCTIVE 3" ROUND BRUSH
3	32043700	5 " UPHOLSTERY NOZZLE
4	01717400	10' ANTISTATIC HOSE WITH CURVED WAND
5	01773300	22" STRAIGHT TUBE (SET OF 2)
6	01773600	FLOOR TOOL
7	81620000	DUST BAG 6.5 LITERS 5 PCS

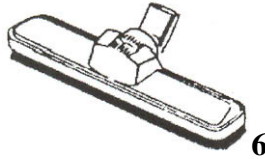
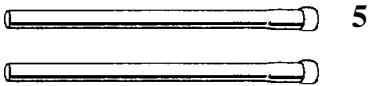
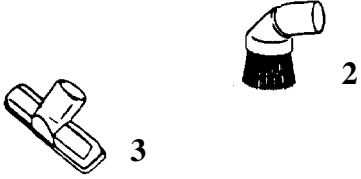

Filter, Filter Bag and Trolley

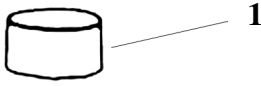

No.	Item No.	Description
1	11730410	MICROFILTER
2	61543000	FILTER KIT COTTON GM 80 MODELS
3	11547000	TROLLEY
4	22410100	SWIVEL WHEEL KIT FOR TROLLEY
5	22384200	REAR WHEELS FOR TROLLEY
6	22384400	CLIP FOR TROLLEY

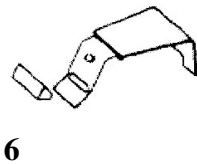
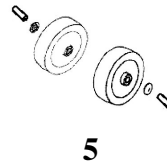
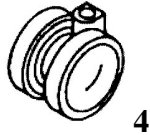
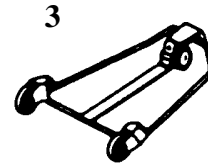
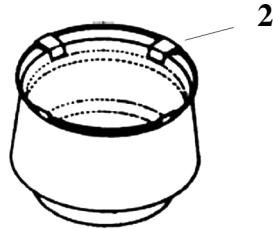

Power Cords

No.	Item No.	Description
1	21827400	9.3M CORD AWG18/3
10	22361000	BRACKET W/ SCREWS FOR CORD

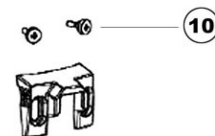
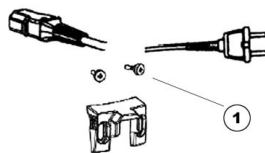

Motors

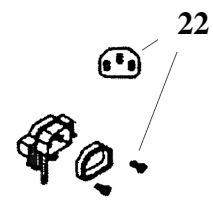
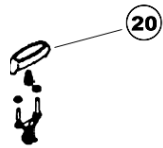
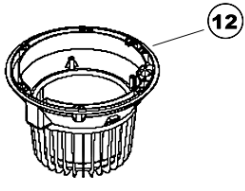
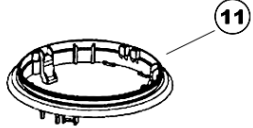
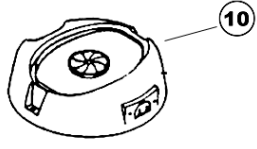
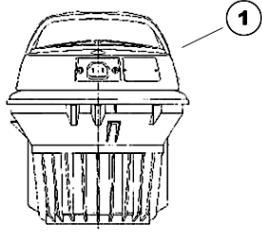

No.	Item No.	Description
1	12110329	MOTOR GMPJ 110-120V.UL
10	22232301	TOP HOUSING FOR GS/GM MOTORS UL APPROVED
11	22410300	SUPPORT RING FOR UL APPROVED GS/GM MOTOR
12	22231201	BOTTOM HOUSING WITH VALVE FOR GM MOTOR UL APPROVED
20	22410500	ON/OFF DEVICE FOR GS/GM MOTORS
21	22410400	LOCKING DEVICE FOR HANDLE GS/GM MOTORS
22	20705500	GROUNDING SOCKET WITH PARTS FOR GM/GS MOTOR HEAD

Internal Motor Components

No.	Item No.	Description
1	12125003	MOTOR GMP/GMPJ 110-120V
2a	22130500	WIRE KIT/THERMO SWITCH FOR UL APPROVED MOTOR
3	22131200	ON/OFF SWITCH 2-POLE
10	22231100	MOTOR SUSPENSION-PHILLIPS
11	22365300	SOUND ABSORBER AND GASKET
12	22399800	GASKET FOR INLET

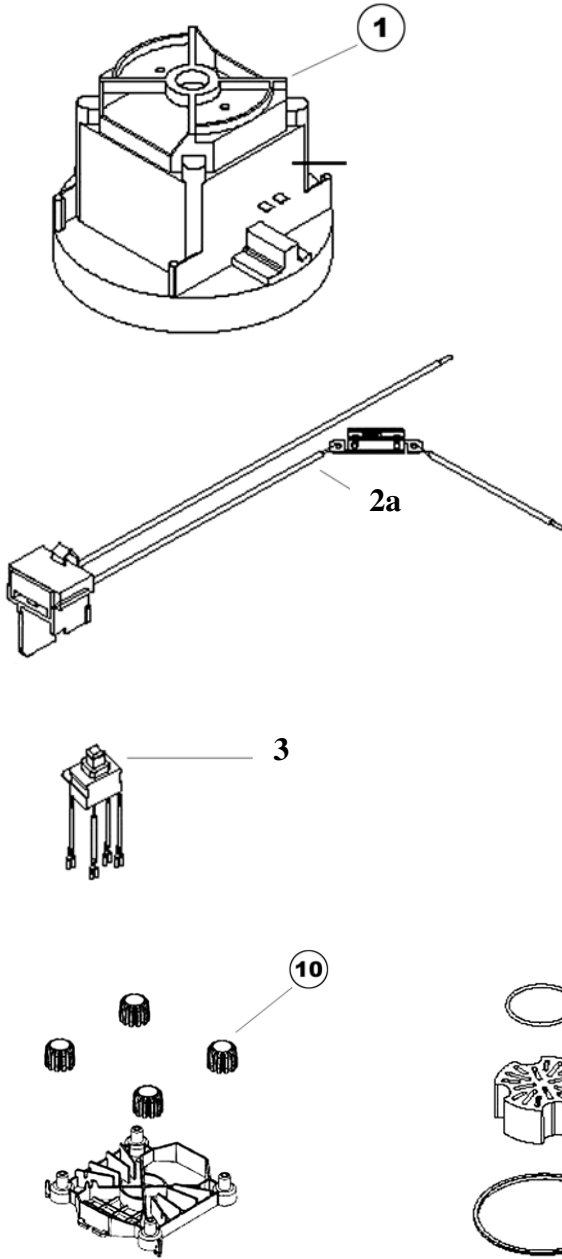

TECHNICAL SPECIFICATIONS

Motor type, grounded	GMPJ
Tank capacity	3 1 /4 gallons
Voltage @ 60 Hz.	110-120/220 volt
Paper bag capacity	2 1 /4 gallons
Current draw	9 amps
Filter area*	1477 square inches
Power watts	1100
Dimensions (l x w x h)	14x12x16 inches
Waterlift**, max.	102 inches H2O
Weight without accessories	11 lbs.
Airflow, max.	87 cfm
Cord length	30 feet
Air performance	250 air watts

* With pressure relief valve inactive

** Filter area includes paper bag, main filter, microfilter and ULPA filter

CONTACT INFORMATION

Nilfisk-Advance America, Inc.
300 Technology Drive
Malvern, PA 19355
Phone: (610) 647-6420
Fax: (610) 647-6427

questions@nilfisk-advance.com
www.pa.nilfisk-advance.com

