

CLEANVIEW[®] USER GUIDE

8531 SERIES

*Product images may vary

IMPORTANT SAFETY INSTRUCTIONS

READ ALL INSTRUCTIONS BEFORE USING YOUR UPRIGHT VACUUM.

Always connect to a polarized outlet (one slot is wider than the other). Unplug from outlet when not in use and before conducting maintenance. When using an electrical appliance, basic precautions should be observed, including the following:

WARNING

TO REDUCE THE RISK OF FIRE, ELECTRIC SHOCK, OR INJURY:

- » Always connect to a polarized outlet (one slot is wider than the other). Do not modify the polarized plug to fit a non-polarized outlet or extension cord.
- » Do not leave vacuum cleaner when it is plugged in. Unplug from outlet when not in use and before servicing.
- » Do not use outdoors or on wet surfaces.
- » Do not allow to be used as a toy. Close attention is necessary when used by or near children.
- » Do not use for any purpose other than described in this User's Guide. Use only manufacturer's recommended attachments.
- » Do not use with damaged cord or plug. If appliance is not working as it should, has been dropped, damaged, left outdoors, or dropped into water, have it repaired at an authorized service center.
- » Do not pull or carry by cord, use cord as a handle, close a door on cord, or pull cord around sharp edges or corners. Do not run appliance over cord. Keep cord away from heated surfaces.
- » Do not unplug by pulling on cord. To unplug, grasp the plug, not the cord.
- » Hold plug when rewinding onto cord reel. Do not allow plug to whip when rewinding.
- » Do not handle plug or vacuum cleaner with wet hands.
- » Do not put any object into openings. Do not use with any opening blocked; keep openings free of dust, lint, hair, and anything that may reduce air flow.
- » Keep hair, loose clothing, fingers, and all parts of body away from openings and moving parts.
- » Turn off all controls before plugging or unplugging vacuum cleaner.
- » Use extra care when cleaning on stairs.
- » Do not use to pick up flammable or combustible materials (lighter fluid, gasoline, kerosene, etc.) or use in areas where they may be present.
- » Do not use vacuum cleaner in an enclosed space filled with vapors given off by oil base paint, paint thinner, some moth proofing substances, flammable dust, or other explosive or toxic vapors.
- » Do not use to pick up toxic material (chlorine bleach, ammonia, drain cleaner, etc.).
- » Do not pick up anything that is burning or smoking, such as cigarettes, matches, or hot ashes.
- » Do not use without filters in place.
- » Do not pick up hard or sharp objects such as glass, nails, screws, coins, etc.
- » Use only on dry, indoor surfaces.
- » Keep appliance on a level surface.
- » Do not carry the vacuum cleaner while it is running.
- » Unplug before connecting or disconnecting the TurboBrush® Tool or TurboEraser® Pet Tool (on select models).

SAVE THESE INSTRUCTIONS FOR FUTURE USE

This model is for household use only.

THIS APPLIANCE HAS A POLARIZED PLUG

To reduce the risk of electric shock, this appliance has a polarized plug (one blade is wider than the other). This plug will fit in a polarized outlet only one way. If the plug does not fit fully in the outlet, reverse the plug. If it still does not fit, contact a qualified electrician to install a proper outlet. Do not change the plug in any way.

Quick Start Guide

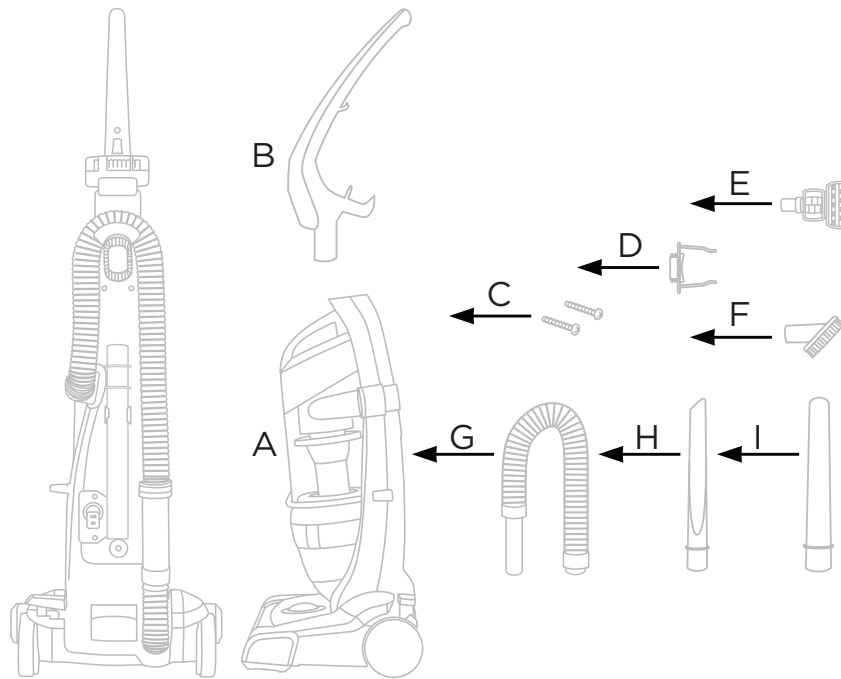

CARTON CONTENTS

- | | |
|--|-------------------|
| A. Vacuum Base | F. Dusting Brush |
| B. Handle | G. Hose |
| C. Screws (2) | H. Crevice Tool* |
| D. Hose Wand Clip | I. Extension Wand |
| E. TurboBrush®/TurboEraser®
Pet tool (on select models) | |

*Note: Crevice tool is located inside Extension Wand

Assembly

1. Slide handle onto machine base
2. Screw 2 screws into existing holes
3. Insert extension wand clip into back of vacuum base and twist clockwise
4. Line up tabs on the cuff of the hose with the notches on back of vacuum, twist hose clockwise to lock into place
5. Slide other end of hose into hose wand base and place hose over upper hose wrap
6. Slide tools into place

*Product images may vary

Thanks for buying a BISSELL vacuum

We're glad you purchased a BISSELL vacuum. Everything we know about floor care went into the design and construction of this complete, high-tech home cleaning system.

Your BISSELL vacuum is well made, and we back it with a limited three-year warranty. We also stand behind it with a knowledgeable, dedicated Consumer Care department, so, should you ever have a problem, you'll receive fast, considerate assistance.

My great-grandfather invented the floor sweeper in 1876. Today, BISSELL is a global leader in the design, manufacture, and service of high quality homecare products like your BISSELL vacuum.

Thanks again, from all of us at BISSELL.

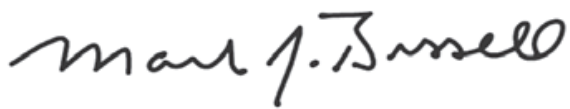

Mark J. Bissell
Chairman & CEO

Safety Instructions.....	2
Quick Start Guide.....	3
Product View.....	5
Assembly.....	6
Operations.....	7-9
Maintenance & Care.....	9-12
Troubleshooting.....	13
Replacement Parts.....	14
Warranty.....	15
Product Registration.....	16
Consumer Care.....	16

Product View



- | | | | |
|--|-----------------------------------|---|-------------------------|
| 1 Handle | 8 Bottom Easy Empty™
Dirt Tank | 15 Cord Clip | 22 Extension Wand Clip |
| 2 Power switch** | 9 Cord Rewind | 16 TurboBrush®/TurboEraser®
Pet Tool** | 23 Power Switch** |
| 3 Tank Release Button | 10 Post-Motor Filter | 17 Upper Hose Wrap | 24 Hose Wand |
| 4 Carry Handle | 11 Height Adjustment Knob | 18 Dusting Brush | 25 Hose Wand Base |
| 5 Suction Power Indicator** | 12 Brush Roll On/Off** | 19 Stretch Hose | 26 Handle Release Pedal |
| 6 Lid Release Button | 13 Furniture Protection Guard | 20 Crevice Tool (Grey) | 27 Foot Hose |
| 7 Pre-Motor Filter (located
inside Dirt Tank lid) | 14 Powerfoot | 21 Extension Wand | |

WARNING

Plastic film can be dangerous. To avoid danger of suffocation, keep away from babies and children.

WARNING

Do not plug in your vacuum cleaner until you are familiar with all instructions and operating procedures.

WARNING

To reduce the risk of electric shock, turn power switch off and disconnect polarized plug from electrical outlet before performing maintenance or troubleshooting checks.

*Product images may vary

** On select models

Assembly

The only tool you'll need to assemble your vacuum cleaner is a Phillips head screwdriver.



WARNING

Do not operate cleaner with damp or wet filters or without vacuum bags and all filters in place.

Attach handle to vacuum

1. Locate the vacuum handle and remove the screw packet taped to the handle. The screw packet contains two screws of equal length.
2. Stand the vacuum upright and slide the base of the handle firmly into the opening at the top of the vacuum body.
3. Check to be sure the handle is fitted to the vacuum body. If there are any gaps between the handle and the vacuum base, continue to push the handle firmly into the base until the handle is flush.
4. Insert the two screws from the screw packet into the existing holes. Push each screw firmly into the hole before beginning to secure the screw with a Phillips head screwdriver. If the handle is aligned properly on the vacuum base, you should be able to push the screw almost entirely into the hole until only the screw head is visible. Tighten the screw with a Phillips head screwdriver by rotating the screw clockwise.



Attach vacuum hose, clips & tools

1. Attach the extension wand clip by inserting the clip into the back of the vacuum base and twisting clockwise. Mount the extension wand (with crevice tool inside) on the back of the vacuum.
2. Attach the Twist 'n Snap™ hose by lining up the tabs on the cuff with the corresponding notches on the back of the vacuum. Twist the Twist 'n Snap hose clockwise to lock the hose into place.
3. Slide the end of the hose wand into the hose wand base, and fold the hose over the upper hose wrap.

NOTE: The powerfoot will not suction properly unless the hose wand is firmly attached.

4. Slide the dusting brush into the opening below the upper hose wrap.
5. The TurboBrush®/TurboEraser® pet tool (on select models) secures to the back of the handle in the mount above the upper hose wrap.

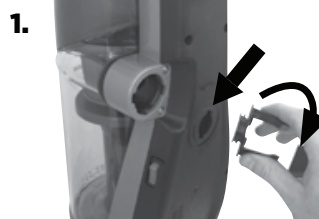

Operations

CAUTION

Before using your vacuum, make sure that the dirt tank is in the locked position and that both filters (pre-motor and post-motor) are in place. Do not operate your vacuum without these filters.

Power switch

The Power switch is located on the front of the handle. Push the button ① once to vacuum, and push the button ① again when cleaning is complete.

Handle position

Press the handle release pedal with your foot to place your CleanView vacuum into one of three cleaning positions.

- 1. Upright** – For storage and above floor cleaning with tools.
- 2. Normal cleaning** – Press handle release for household floor cleaning tasks.
- 3. Low cleaning** – With the vacuum in normal cleaning position, press handle release pedal again, use for reaching under low furniture such as tables, chairs or beds.



Height adjustment

There are five height settings available for various floor surfaces. Turn the dial on the foot of the cleaner to the desired setting.

Lowest setting – For low pile carpet or bare floors. To pick up debris, it may be necessary to move up one setting.

Medium setting – For medium pile carpet.

Highest setting – For high pile and most shag carpet.

NOTE: For optimal carpet cleaning performance, adjust to the lowest practical setting. If your cleaner is difficult to push, adjust to the next higher setting.

If the dial is difficult to turn, tilt the cleaner back slightly to take the weight off the foot while turning.

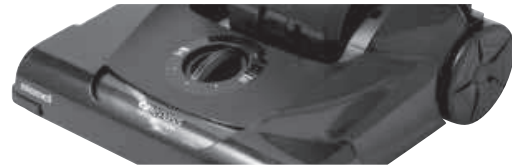

Transporting cleaner

- To move your cleaner from room to room, put the handle in the upright position, tilt the cleaner back on its rear wheels and push forward.
- The cleaner can also be moved by using the carrying handle.



TIPS

» Hair, string and small objects can block the vacuum hose or tools. Check them occasionally for obstructions.

» Before cleaning under low furniture, check area first for objects that might harm the unit or block the vacuum hose.

*Product images may vary

Operations

Suction Power Indicator

The suction power indicator tells you when the air flow in your vacuum is reduced due to dirty filters or a clog in the hose. The suction power indicator will remain green until the airflow is reduced. At that time, it begins to change to red. When it is fully red, the airflow is significantly reduced by a dirty filter or clog. Follow the steps on page 12 for clearing a clog. Follow the steps on pages 9 and 10 to clean your filters. All filters in the vacuum should be cleaned or replaced when the clean filter indicator turns red.

NOTE: When your vacuum is turned off, the suction power indicator will go to the green color setting. The suction power indicator only detects reductions in airflow when the vacuum power is on.

Special tools

Your BISSELL CleanView vacuum is not only a powerful carpet and rug vacuum cleaner, it's also a versatile above floor vacuum cleaner when you select one of the special tools.

1. Raise handle to upright position.
2. Grasp the hose wand and separate from the hose wand base.
3. Attach tools by firmly pushing onto vacuum hose or extension wand.
 - a. **Crevice tool** Use in tight narrow spaces.
 - b. **Dusting Brush** Use brush to dust furniture, blinds, books, lamps, shelves and baseboards.
 - c. **Extension wand** Use with desired attachment for a longer reach.
 - d. **TurboBrush®/TurboEraser® pet tool (on select models)** Use rotating brush action for small flat areas such as stairs and cushions. Press gently down and pull toward you in a raking motion; too much pressure will cause the brush to stop rotating.



Tip

» Hair, string and small objects can block the vacuum hose or tools. Check them occasionally for obstructions.

NOTICE

Pet Hair Lifter (Pet select models)

Just vacuum like you normally would and the pet hair lifter will grab pet hair when you pull back and suction it up when you push forward.



Tip

» The crevice tool is located inside the wand

Automatic Cord Rewind

1. Gently pull out power cord and stop when yellow is visible. Do not pull power cord beyond the red line. Plug cord into electrical outlet.
2. To return cord, turn vacuum power switch off, and remove plug from outlet. Hold plug and press automatic cord button to wind cord into reel. Do not allow plug to whip when rewinding.

Operations

Brush Roll On/Off

The rotating brush On/Off pedal is located on the front of the vacuum base. You can use your foot to engage or disengage this pedal (a). When the brush roll pedal has been engaged, the brush will start rotating. The brush roll should be turned on for most carpeted floors. To turn the brush roll off, disengage the pedal by pressing on it with your foot. We recommend turning off the brush roll for bare floor cleaning to prevent scatter or for other delicate surfaces.

NOTICE

The floor brush will continue to rotate while you use your vacuum for above floor cleaning. To prevent carpet damage, do not lean on the vacuum or let the powerhead tilt forward. This effects models without a brush roll on/off switch.

a.



Maintenance & Care

To maintain maximum cleaning performance, the following maintenance steps must be performed:

1. Empty the dirt tank when the dirt reaches the "Full" line on the side. (See page 10)

2. Check the pre-motor filter at least once a month and clean or replace as needed.

To access the pre-motor filter, remove the Easy Empty dirt tank from the vacuum base and push the lid release button located on the carry handle. Remove the foam filter from the filter tray. A second small, black odor-absorbing carbon filter can also be found here. Replace this as needed.

3. The post-motor filter assists in the filtration process to return clean air to the room. Replace the post-motor filter every three to six months. To access the post-motor filter, remove the filter tray located below the Easy Empty dirt tank. When the filter becomes dirty, push the filter through the bottom of the tray to clean or replace the filter.

NOTE: The pleated post-motor filter may NOT be washed with water or detergent. If dust and/or debris accumulates on the filter, gently tap the filter on the side of a garbage container.

Note: More frequent filter cleaning or replacing may be necessary if you are vacuuming new carpet, fine dust, or have allergy concerns. Follow the instructions on the following pages to perform these simple maintenance steps.

⚠ WARNING

To reduce the risk of electric shock, turn power switch off and disconnect polarized plug from electrical outlet before performing maintenance or troubleshooting checks.

2.



washable
filter

▼
Lid Release
Button

3.



Post-Motor
Filter Tray

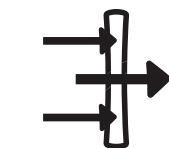

pull for filter

NOTICE

While vacuuming, certain carpets and low humidity conditions may generate small static discharges. The discharges are entirely harmless and are not associated in any way with the main power supply.

Maintenance & Care

Empty Dirt Tank

The dirt tank needs to be emptied when the dirt reaches the “Full” line on the side of the tank.

1. Unplug cleaner from electrical outlet.
2. Remove the Easy Empty dirt tank from the vacuum base by pushing the tank release button.
3. Hold the dirt tank over a garbage container. Press the bottom lid release button on the back of the dirt tank to empty dirt.
4. Mount the Easy Empty dirt tank back on the vacuum base.

NOTE: The dirt tank may be washed in warm water with a mild detergent. Make sure it is completely dry before replacing.

Cleaning the pre-motor filter and inner cyclone

Use only genuine BISSELL replacement filters in your BISSELL CleanView vacuum.

1. Unplug the cleaner from electrical outlet.
2.
 - a. Remove the Easy Empty dirt tank and locate the pre-motor filter as described on the previous page.
 - b. Remove the foam filter from the filter tray. The filter tray is fixed in-place, but may be removed for cleaning by unscrewing the tray. The foam filter and tray may be hand washed in warm water with a mild detergent, if desired. Rinse well, then air dry thoroughly before replacing the filter. Make sure all components are completely dry before replacing. A second black odor-absorbing filter can also be found here. Replace this when needed. Note, this is not washable.

3. The inner cyclone may also be removed for cleaning. With the bottom of Easy Empty dirt tank open, reach up into the dirt cup and grasp the cyclone. Twist the cyclone clockwise to unlock and pull straight down to remove. Use the Lock and Unlock Icons on the tank to help guide the cyclone back in and lock it correctly. It is important to lock the cyclone back in correctly as it will impact performance and separation. The inner cyclone and dirt cup may be wiped clean with a damp cloth. Make sure all parts are dry before replacing.

WARNING

To reduce the risk of electric shock, turn power switch off and disconnect polarized plug from electrical outlet before performing maintenance or troubleshooting checks.

2.



3.



2a.



2b.

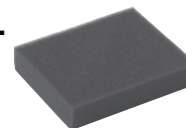

3.



Tip

» When replacing the inner cyclone after cleaning, open the pre-motor filter lid to help guide the inner cyclone into the grooves at the top of the tank. Twist counterclockwise to lock the inner cyclone into place.

WARNING

Do not operate cleaner with damp or wet filters or without all filters in place.

NOTICE

Do not place the dirt tank or other product components in the dishwasher. Hand wash only.

Maintenance & Care

Replacing the post-motor filter

Use only a genuine BISSELL replacement post-motor filter in your BISSELL CleanView vacuum.

1. Unplug the cleaner from electrical outlet.
2. The post-motor filter assists in the filtration process to return clean air to the room. Replace the post-motor filter every three to six months. To access the post-motor filter, remove the filter tray located below the Easy Empty dirt tank. When the filter becomes dirty, push the filter through the bottom of the tray to clean or replace the filter.

NOTE: The pleated post-motor filter may NOT be washed with water or detergent. If dust and/or debris accumulates on the filter, gently tap the filter on the side of a garbage container.

2.

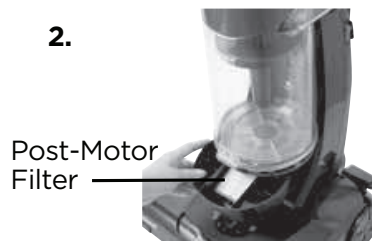

Checking rotating floor brush and drive belt

You should check your vacuum cleaner's rotating floor brush and drive belt regularly for wear or damage. You should also clean the brush and brush ends of strings, hair and carpet fibers. These can wrap around the brush and hamper its ability to effectively clean your carpet. Also remove any debris that has accumulated under the brush cover.

1. Unplug cleaner from electrical outlet.
2. Place handle in low position and turn vacuum cleaner over so bottom side is up.
3. Remove the seven screws with a Phillips head screwdriver. Lift the brush cover off.
4. Grasp rotating floor brush at both ends and lift straight out of the vacuum foot. Slip off the belt.
5. Clean strings, hair and other debris from rotating floor brush, paying particular attention to brush ends.
6. Clean strings, hair and other debris from motor pulley and drive belt areas.
7. Check drive belt carefully for wear, cuts or stressed areas, and replace if necessary (see instructions on following page).
8. Check air passageway for obstructions. Remove debris from this area.

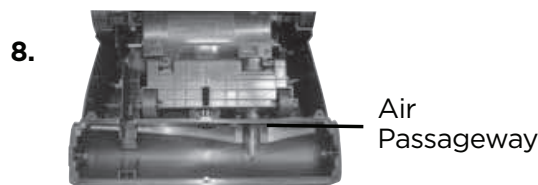
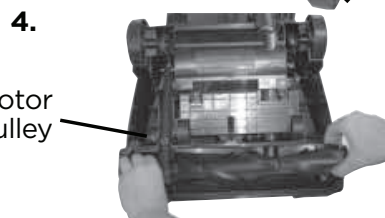
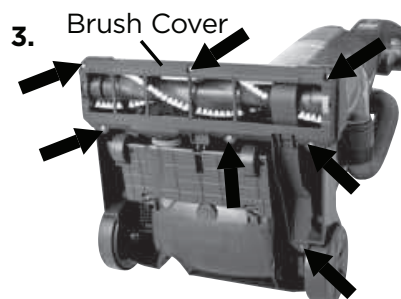

Maintenance & Care

Replace drive belt

Use only a genuine BISSELL style 9 replacement belt (#203-1093) in your BISSELL CleanView vacuum.

1. Unplug cleaner from electrical outlet.
2. With rotating floor brush removed from vacuum cleaner (steps 1-4 of Check rotating floor brush and drive belt), grasp old drive belt and remove from motor pulley. Discard old drive belt.
3. Place new drive belt over motor pulley and stretch other end over rotating floor brush in the space between the bristles.
4. Place ends of rotating floor brush down into slots on sides as shown.
5. Turn rotating floor brush by hand several times in the direction of motor pulley. If properly installed, drive belt will center itself on rotating brush.
6. Reposition the brush cover and screw all seven screws back into place.

WARNING

To reduce the risk of electric shock, turn power switch off and disconnect polarized plug from electrical outlet before performing maintenance or troubleshooting checks.

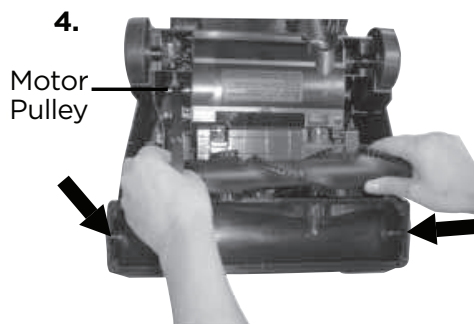

WARNING

To reduce the risk of injury from moving parts, turn off vacuum cleaner and disconnect Power Plug from electrical outlet.

Clearing a clog

Low suction or poor pickup may be due to a clog in the vacuum cleaner. If you notice a change in the sound of the motor or a reduction in the spinning action, check for clogs.

1. Unplug cleaner from electrical outlet.
2. Remove Easy Empty dirt tank from vacuum base and empty dirt and debris.
3. Remove inner cyclone from Easy Empty dirt tank (see page 10) and check for debris build-up or clogs in the upper tank.
4. Check the suction inlet for a clog.
5. Grasp the hose wand to separate from the hose wand base. Check for a clog in the base, the wand or within the hose.
6. Remove the screw attaching the hose wand base to the vacuum. Straighten the hose wand base and check for clogs with a long, narrow object such as a broom stick. Do not use sharp objects like a clothes hanger, as these may puncture the hose.
7. If the clog persists, follow the instructions for Checking the rotating floor brush on page 11 and inspect the air passageway for obstructions.

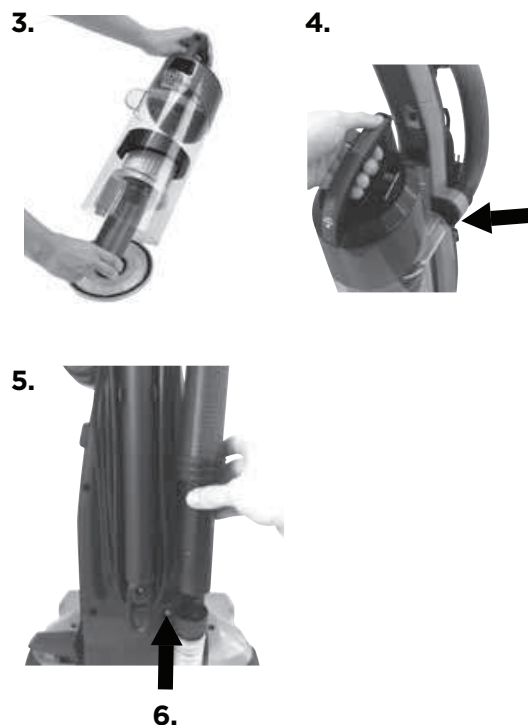

Troubleshooting

WARNING

To reduce the risk of electric shock, turn power switch off and disconnect polarized plug from electrical outlet before performing maintenance or troubleshooting checks.

Problem	Possible causes	Remedies
Vacuum cleaner won't turn on	Power cord not plugged in	Check electrical plug
	Blown fuse/tripped breaker	Check/replace fuse or reset breaker
Vacuum cleaner won't pick up dirt	Incorrect height adjustment	Adjust powerfoot to correct height setting
	Hose not attached to suction opening	Grasp the hose wand and firmly push into the hose wand base
	Crack or hole in hose	Check hose and replace if needed
	Broken or worn drive belt	Replace drive belt, see page 11
	Rotating floor brush bristles worn	Replace brush
	Rotating floor brush jammed	Remove brush and clean debris from brush ends, see page 11
	Clog in vacuum	Follow instructions on page 12 for clearing clogs
	Dirt tank full	Empty dirt tank
	Dirt tank or upper tank not installed properly	Position correctly and lock in place
Filters are dirty	Check and clean or replace pre-motor and post-motor filters, see pages 9, 10	
Tool won't pick up	Crack or hole in hose	Check hose and replace if needed
	Clog in vacuum	Follow instructions on page 12 for clearing clogs
	Dirt tank full	Empty dirt tank
	Dirt tank or upper tank not installed properly	Position correctly and lock in place
	Filters are dirty	Check and clean or replace pre-motor and post-motor filters see pages 9, 10
Vacuum cleaner difficult to push	Incorrect height adjustment	Adjust powerfoot to correct height setting
Visible dirt escaping from cleaner	Dirt tank full	Empty dirt tank
	Filters missing or installed incorrectly	Check pre-motor and post-motor filters for correct installation
Cord will not retract	Knotted or twisted	Follow instructions on page 8

Please do not return this product to the store.





Other maintenance or service not included in the manual should be performed by an authorized service representative.

Thank you for selecting a BISSELL product.

For any questions or concerns, BISSELL is happy to be of service. Contact us directly at 1-800-237-7691.





Replacement Parts

These items are available for your BISSELL CleanView Deluxe Vacuum.
Call 1-800-237-7691 or visit www.bissell.com

PART #	PART NAME		PART #	PART NAME	
203-2665	Hose Assembly		203-1093	Style 9 Drive Belt (2-Pack)	
160-1504	Brush Roll (15", 8531 Series)		1008	Filter pack (includes one pre-motor filter and one post-motor filter)	

Accessories

These items are available for your BISSELL CleanView Deluxe Vacuum.
Call 1-800-237-7691 or visit www.bissell.com

PART #	PART NAME		PART #	PART NAME	
160-1510	TurboEraser Pet Tool		203-1527	Dusting Brush	
203-1056	Crevice Tool		160-1512	Extension Wand	

Warranty

This warranty gives you specific legal rights, and you may also have other rights which may vary from state to state. If you need additional instruction regarding this warranty or have questions regarding what it may cover, please contact BISSELL Consumer Care by E-mail, telephone, or regular mail as described below.

Limited Three-Year Warranty

Subject to the *EXCEPTIONS AND EXCLUSIONS identified below, upon receipt of the product BISSELL will repair or replace (with new or remanufactured components or products), at BISSELL's option, free of charge from the date of purchase by the original purchaser, for three years any defective or malfunctioning part.

See information on "If your BISSELL product should require service".

This warranty applies to product used for personal, and not commercial or rental service. This warranty does not apply to fans or routine maintenance components such as filters, belts, or brushes. Damage or malfunction caused by negligence, abuse, neglect, unauthorized repair, or any other use not in accordance with the User's Guide is not covered.

BISSELL IS NOT LIABLE FOR INCIDENTAL OR CONSEQUENTIAL DAMAGES OF ANY NATURE ASSOCIATED WITH THE USE OF THIS PRODUCT. BISSELL'S LIABILITY WILL NOT EXCEED THE PURCHASE PRICE OF THE PRODUCT.

Some states do not allow the exclusion or limitation of incidental or consequential damages, so the above limitation or exclusion may not apply to you.

*EXCEPTIONS AND EXCLUSIONS FROM THE TERMS OF THE LIMITED WARRANTY

THIS WARRANTY IS EXCLUSIVE AND IN LIEU OF ANY OTHER WARRANTIES EITHER ORAL OR WRITTEN. ANY IMPLIED WARRANTIES WHICH MAY ARISE BY OPERATION OF LAW, INCLUDING THE IMPLIED WARRANTIES OF MERCHANTABILITY AND FITNESS FOR A PARTICULAR PURPOSE, ARE LIMITED TO THE THREE YEAR DURATION FROM THE DATE OF PURCHASE AS DESCRIBED ABOVE.

Some states do not allow limitations on how long an implied warranty last so the above limitation may not apply to you.

NOTE: Please keep your original sales receipt. It provides proof of date of purchase in the event of a warranty claim.

Service

If your BISSELL product should require service:

Visit BISSELL.com or contact BISSELL Consumer Care to locate a BISSELL Authorized Service Center in your area.

If you need information about repairs or replacement parts, or if you have questions about your warranty, contact BISSELL Consumer Care.

Website or E-mail:

www.BISSELL.com

Or Call:

BISSELL Consumer Care

1-800-237-7691

Monday - Friday 8am - 10pm ET

Saturday 9am - 8pm ET

Sunday 10am - 7pm ET

Or Write:

BISSELL Homecare, Inc.

PO Box 3606

Grand Rapids, MI 49501

ATTN: Consumer Care

Register your product today!

Registering is quick, easy and offers you benefits over the lifetime of your product.
You'll receive:

BISSELL Rewards Points

Automatically earn points for discounts and free shipping on future purchases.

Faster Service

Supplying your information now saves you time should you need to contact us with questions regarding your product.

Product Support Reminders and Alerts

We'll contact you with any important product maintenance reminders and alerts.

Special Promotions

Optional: Register your email to receive notice of offers, contests, cleaning tips and more!

Visit www.BISSELL.com/registration now!

BISSELL Consumer Care

For information about repairs or replacement parts, or questions about your warranty:

Call:

BISSELL Consumer Care
1-800-237-7691

Monday - Friday 8 am - 10 pm ET
Saturday 9 am - 8 pm ET
Sunday 10am - 7pm ET

Write:

BISSELL Homecare, Inc.
PO Box 3606
Grand Rapids MI 49501
ATTN: Consumer Care

Visit the BISSELL website: www.BISSELL.com

When contacting BISSELL, have model number of cleaner available.

Please record your Model Number: _____

Please record your Purchase Date: _____

NOTE: Please keep your original sales receipt. It provides proof of purchase date in the event of a warranty claim. See Warranty on page 15 for details.



©2013 BISSELL Homecare, Inc.
Grand Rapids, Michigan
All rights reserved. Printed in China
Part Number 160-0179 Rev 7/13
Visit our website at: www.BISSELL.com