

Honeywell

enviraire®

Portable Air Cleaners

READ AND SAVE THESE INSTRUCTIONS

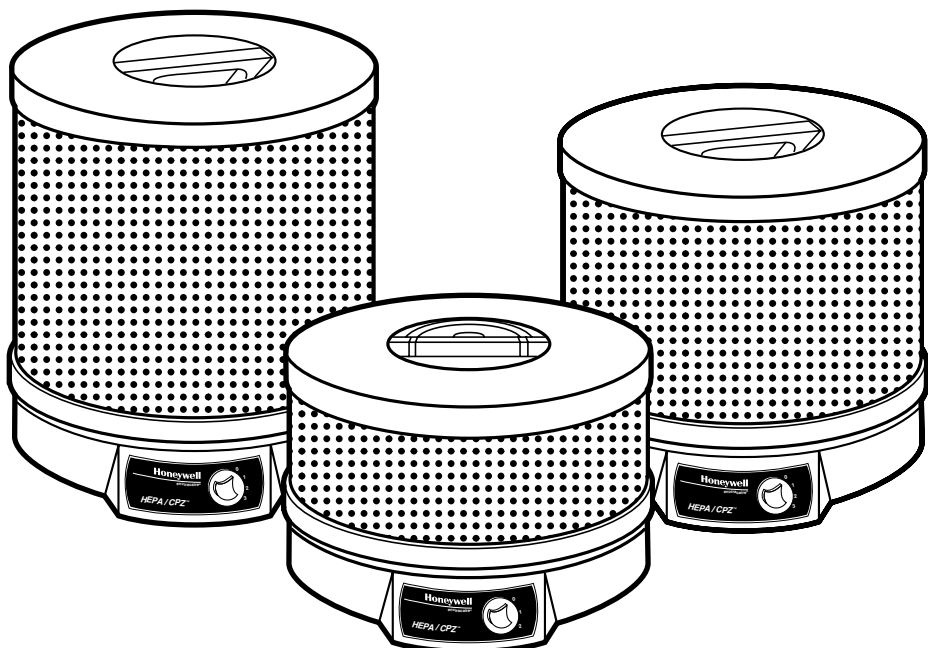

Owner's Guide

For Model Series
61200 • 63200 and 64200
Series Air Cleaners

The Science of Clean Air

Important Safety Instructions...

Please read all instructions before using this product. Save these instructions for easy reference.

When using electrical appliances, basic precautions should always be followed to reduce breakage, risk of fire, electric shock and injury to persons including the following:

1. Read all instructions before operating the air cleaner.
2. Place air cleaner where it is not easily knocked over by persons in the household.
3. Always unplug when not in use, and before changing filter.
4. Do not use any product with a damaged cord or plug or if product malfunctions, is dropped or damaged in any manner. Keep the cord away from heated surfaces.
5. Do not use air cleaner outdoors except as described in this owners manual.
6. Never use air cleaner unless it is fully assembled and all filter elements are in place.
7. Do not pull on or carry by the cord, use the cord as a handle, close a door on the cord or place cord in contact with sharp edges or corners. Do not run power cord under carpets or cover with throw rugs. Arrange cord such that it will not be tripped over.
8. Do not use air cleaner where combustible gases or vapors are present.
9. Do not operate the air cleaner in a bathroom, laundry area or other damp locations.
10. To disconnect the air cleaner, first turn speed control to OFF position and remove plug from the outlet.
11. The air cleaner must be used in its upright position.
12. Do not allow foreign objects to enter ventilation or exhaust opening as this may cause electric shock or damage to the air cleaner. Do not block air outlets or intakes.
13. Locate air cleaner near power outlet and avoid using an extension cord. If it is necessary to use an extension cord, use a heavy duty cord with adequate line size. **DO NOT** use light duty extension cords intended for lamps.
14. The air cleaner has a polarized plug (one blade is wider than the other). To reduce risk of shock, this plug is intended to fit in a polarized outlet only one way. If the plug does not fit fully in the outlet, reverse the plug. If it still does not fit, contact a qualified electrician. **DO NOT** attempt to defeat this safety feature.
15. A loose fit between the plug and the AC outlet (receptacle) may cause over heating and a distortion of the plug. Contact a qualified electrician to replace loose or worn receptacles.
16. Do not sit, stand or place heavy objects on the air cleaner.
17. **WARNING:** To reduce the risk of fire or electric shock, do not use this product with any solid state speed control device.

Congratulations...

You now own a powerful and highly efficient portable air cleaner.

Our customer service center representatives will be pleased to help with any questions or concerns you may have about your Honeywell air cleaner. Please call our Consumer Relations Dept. at (800) 332-1110 for assistance.

Quality/Reliability...

Your air cleaner is quality engineered for simplicity and reliability and is manufactured with durable, high impact plastic housings which are scratch, stain, and corrosion resistant. With reasonable care and replacement of filters as recommended, it will give you years of trouble free performance.

Before Operating Your Air Cleaner

- **Read this owners manual and follow all safety instructions.**
- **Carefully remove the plastic bag which protects the CPZ™ sorbent media cartridge during shipment. Your air cleaner will not operate properly with the plastic bag in place, and it may damage the air cleaner. The plastic bag may contain small particles and dust caused by vibration of the CPZ™ sorbent media cartridge during shipment. Use care to avoid soiling clothing, carpets, and other furnishings with the particles or dust. See the "How to Change the Filters..." section of this owners manual for filter removal instructions.**
- **Operate your air cleaner outdoors for about 3 minutes to fully discharge any residual dust which may remain in the CPZ™ sorbent media cartridge. Failure to follow this procedure could result in minor amounts of dust deposits on floor and furnishings. DO NOT OPERATE THE AIR CLEANER IN A WET OR DAMP ENVIRONMENT AND DO NOT LEAVE IT UNATTENDED DURING THIS PROCEDURE.**

61200 Series...

The **Honeywell** 61200 Series air cleaner is a 2 speed air cleaner operated by moving the speed control knob on the base from the Off ("0") position to the high ("2") position. Allow the unit to operate for a few minutes at high speed, then leave the control knob in the high position for faster, powerful room cleaning, or move the knob to the lower setting for quieter operation.

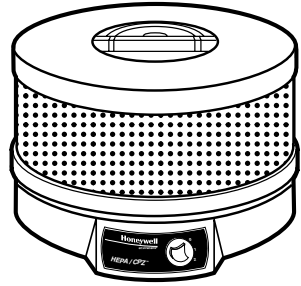

63200 Series...

The **Honeywell** 63200 Series air cleaner is a 3 speed air cleaner operated by moving the speed control knob in the base from the Off ("0") position to the high ("3") position. Allow the unit to operate for a few minutes at high speed, then leave the control knob in the high position for faster, powerful room cleaning, or move the knob to the lower setting for quieter operation.

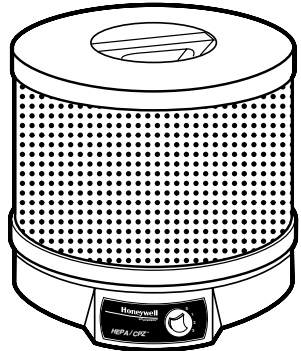

64200 Series...

The **Honeywell** 64200 Series air cleaner is a 3 speed air cleaner operated by moving the speed control knob on the base from the Off ("0") position to the high ("3") position. Allow the unit to operate for a few minutes at high speed, then leave the control knob in the high position for faster, powerful room cleaning or move the knob to the lower setting for quieter operation.

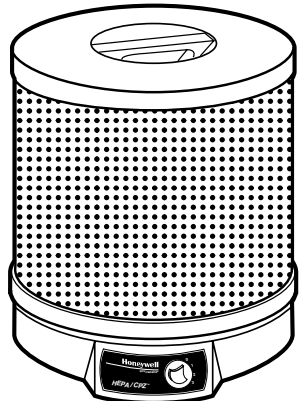

Construction ...

Your **Honeywell** air cleaner has six basic components: the base assembly (with controls and motor), the lid assembly, the protective screen, the activated carbon pre-filter, the HEPA filter, and the CPZ™ sorbent media cartridge

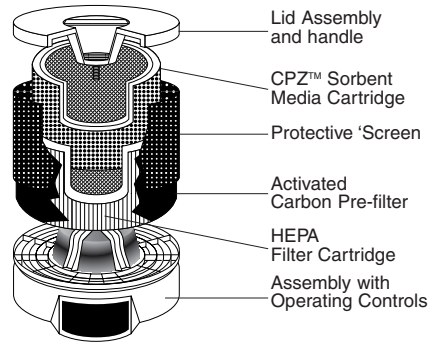

For Best Performance ...

We recommend that you operate your **Honeywell** air cleaner 24 hours a day because indoor air can be quickly contaminated by activity in a room, infiltration of outside air, and generation by sources of contamination.

The **Honeywell** air cleaner is ready to begin cleaning air as soon as it is removed from the carton, the protective bag on the CPZ™ sorbent media cartridge is removed, and the unit is operated outdoors for a few minutes. **See “Before Operating Your Air Cleaner..”** For best performance the air outlet slot should not be blocked for at least three feet in all directions.

Replacement Filters...

Select the proper replacement filter for your **Honeywell** air cleaner from the chart below:

<u>Model No.</u>	<u>HEPA Filter Part Number</u>	<u>CPZ™ Cartridge Part Number</u>	<u>Carbon Pre-filter Part Number</u>
61200	28720	36210	32002
63200	28600	36200	34002
64200	29200	36220	35002

Replacement filters may be purchased from the retail store or ordered from the dealer where you purchased the product. If you cannot locate one in your area, please call our Consumer Relations Dept. at (800) 322-1110 and we will direct you to a stocking dealer.

Filter Replacement...

With proper maintenance, your **Honeywell** air cleaner is designed to provide years of high efficiency air cleaning. Your Honeywell air cleaner contains three filters: one activated carbon pre-filter, one primary HEPA filter, and one CPZ™ sorbent media cartridge.

The activated carbon pre-filter helps capture large airborne particles, and helps remove odors. The pre-filter should be replaced every 3 months. You may need to replace the pre-filter more often if the unit is used in a smoking environment or if unpleasant odors persist.

The primary HEPA filter should remain effective for 1 to 3 years, depending upon the environment in which the air cleaner is operating. Honeywell recommends changing the HEPA filter based upon operation conditions—every 3 years for light usage, 2 years for normal usage and 1 year for heavy usage.

The CPZ™ sorbent media cartridge should be replaced every 12 to 18 months, or more frequently if its odor adsorption capacity has been consumed. When its adsorbing capacity has been reached, it will emit a persistent foul odor indicating that it should be replaced.

Our recommendations regarding filter replacement intervals are intended as guidelines only. The life expectancy of any filter media is dependent on the concentration of the contaminants to which the system is exposed. If there are sources of large amounts of contaminant generation (such as woodworking, painting or heavy smoking) the useful life of the filter media in your air cleaner may be reduced.

Whenever the combined air resistance of the activated carbon pre-filter and primary HEPA filter becomes excessive due to the amount of contaminants they have captured, the air cleaner will begin to audibly pulsate. Instead of a steady stream of air, rapid "puffs" of air may be felt at the outlet slot. When this occurs, one of two conditions exists:

1. The activated carbon pre-filter is clogged and must be replaced.
2. If the unit continues to pulsate after a new pre-filter is installed, the useful life of the HEPA filter has been reached and it must be replaced.

Important...

Replace the activated carbon pre-filter at least every 3 months. The activated carbon pre-filter is the element of your air cleaner that helps remove odors and gaseous compounds and helps protect the life of the HEPA filter. Under normal household conditions the odor adsorption capability will be used up in about 3 months. If there are heavy concentrations of odors, smoke, or gases (such as tobacco smoke) in the home, you may need to change the activated carbon pre-filter more often.

We **DO NOT** recommend operating the air cleaner without the activated carbon pre-filter or CPZ™ sorbent media cartridge because the primary HEPA filter does **NOT** absorb odors or gaseous compounds. In fact, the HEPA filter may become contaminated by these odors and begin to emit the odor captured.

CAUTION: Do not attempt to wash the activated carbon pre-filter, HEPA filter or the CPZ™ sorbent media cartridge. They are not washable and will be damaged if cleaned.

How to Change the Filters...

CAUTION: DISCONNECT FROM POWER SUPPLY BEFORE SERVICING

The only three parts requiring any service are the activated carbon pre-filter, HEPA filter and the CPZ™ cartridge. No tools are needed to change a filter. Disassemble the unit as shown.

1. Loosen the carrying handle by turning it counterclockwise. Lift the lid and protective screen from unit.
2. Lift HEPA filter and activated carbon pre-filter from the base. The CPZ™ cartridge can be removed separately and replaced as needed.
3. Remove the two plastic clips from the top and bottom of the activated carbon pre-filter and remove it from the HEPA filter. Replace either filter as needed.
4. Wrap the activated carbon pre-filter around the HEPA filter and secure with plastic clips.

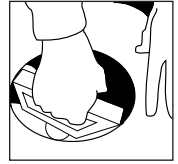

Reassemble your **Honeywell** air cleaner as described below:

1. Place the assembled HEPA filter and activated carbon pre-filter on the base. Place the CPZ™ cartridge into place on the base.
2. Replace the lid and protective screen.
3. Reattach the carrying handle and turn it clockwise until securely tightened.

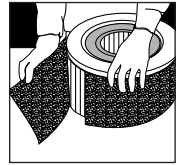

If the Air Cleaner Does Not Operate...

- Check to make sure that the power cord is correctly connected to the outlet.
- Test the outlet with another appliance or lamp.
- Check the fuse or circuit breaker. The outlet may be overloaded if other appliances are also in use. Determine and correct the cause of the overload.
- The thermal overload protection device on the air cleaner's motor may have engaged. Turn the air cleaner's motor control to OFF and wait 30 to 45 minutes. Then, plug it in and turn ON again.
- If none of the above procedures restore operation, return your unit to the store in accordance with store policy, or return the complete unit per the instructions in the warranty section of this owner's guide. Do not attempt to repair the unit yourself.

Storage...

If you store your **Honeywell** air cleaner for more than 30 days, we recommend:

- Remove both the primary HEPA filter and the activated carbon pre-filter from the unit.
- Discard the pre-filter.
- Wrap the HEPA filter and CPZ™ sorbent media cartridge in separate air-tight plastic bags or plastic wrap. Be sure that the HEPA filter and CPZ™ sorbent media cartridge are totally sealed.
- To restore the air cleaner to service, unwrap the HEPA filter and CPZ™ sorbent media cartridge, install a new pre-filter, and reinstall all filters in the air cleaner. See "How to change the Filters..." section for proper installation.

CAUTION: If the CPZ™ sorbent media cartridge is not completely sealed, it will continue to adsorb gas phase compounds during storage and may need to be replaced when the air cleaner is restored to service.

Limited Warranty...

Honeywell HEPA CPZ™ Air Cleaner

Model No. 61200, 63200 and 64200

This product has been engineered and crafted with great care for your satisfaction. **Be sure to fill out and return the enclosed card within 7 days of purchase.**

A. This 5 year limited warranty applies to repair or replacement of product found to be defective in material or workmanship. This warranty does not apply to damage resulting from commercial, abusive, unreasonable use or supplemental damage. Defects that are the result of normal wear and tear will not be considered manufacturing defects under this warranty. HONEYWELL CONSUMER PRODUCTS BUSINESS IS NOT LIABLE FOR INCIDENTAL OR CONSEQUENTIAL DAMAGES OF ANY NATURE. ANY IMPLIED WARRANTY OF MERCHANTABILITY OR FITNESS FOR A PARTICULAR PURPOSE ON THIS PRODUCT IS LIMITED IN DURATION TO THE DURATION OF THIS WARRANTY. Some states do not allow the exclusion or limitation of incidental or consequential damages or limitations on how long an implied warranty lasts, so the above limitations or exclusions may not apply to you. This warranty gives you specific legal rights, and you also may have other rights which vary from state to state. This warranty applies only to the original purchaser of this product.

B. At its option, Honeywell will repair or replace this product if it is found to be defective in material or workmanship. Defective product should be returned immediately to Honeywell.

C. This warranty does not cover damage resulting from unauthorized attempts to repair or from any use not in accordance with this manual.

D. This warranty **DOES NOT** cover the pre-filter, HEPA filter or CPZ™ sorbent media cartridge except for material or workmanship defects.

E. Return defective product to the following address with a brief description of the problem. Include proof-of-purchase and a U.S. \$10.00/Can \$13.00 check or money order for handling, return packing and shipping charges. Please include your name, address and daytime phone number. You must prepay shipping charges. Mark carton "**Attention Repair Department**"

Ship to:

Honeywell Consumer Products Business
Honeywell, Inc.,
4755 Southpoint Drive
Southpoint Distribution Center
Memphis, TN 38118
U.S.A.

If you experience a problem with your air cleaner, please see owner's guide for instructions. Please do not attempt to repair the air cleaner yourself. Doing so will void the warranty and could cause damage or personal injury. If the problem still persists, please call:

Honeywell Consumer Products Business
Honeywell Inc.
Consumer Relations Dept.
Toll Free 1-800-332-1110.

Business Hours:
Mon.–Fri. 8:00am–10:00pm (EST).
Sat.–Sun. 8:30am–5:00pm (EST).

Mail Questions or Comments to:

Honeywell Consumer Products Business
Honeywell Inc.
Consumer Relations Dept.
250 Turnpike Road
Southborough, MA 01772
U.S.A.