

# OMRON

## INSTRUCTION MANUAL

COMP *A-I-R*™ Pro

# Compressor Nebulizer

## Model NE-C29

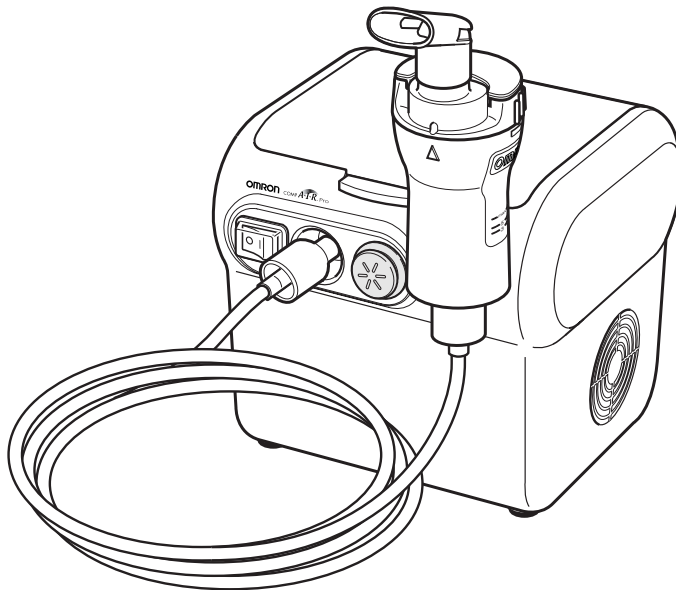

All for Healthcare

10/2011  
1649823-2D

# CONTENTS

## Before Using the Unit

- Intended Use . . . . .2
- Important Safety Notes . . . . .3
- Know Your Unit . . . . .6
- Guide to Using the NE-C29 . . . . .8

## Operating Instructions

- How to Prepare the Nebulizer for Use . . . . .9
- How to Take Medication . . . . .13

## Care and Maintenance

- Cleaning and Daily Disinfecting . . . . .16
- Maintenance and Storage . . . . .17
- How to Change the Air Filter . . . . .19
- Troubleshooting Tips . . . . .20
- Specifications . . . . .21
- Optional Parts and Accessories . . . . .25

## INTENDED USE

<b>Medical Purpose</b>	This product is intended to be used for inhaling medication for respiratory disorders.																
<b>Intended User</b>	<ul style="list-style-type: none"> <li>• Legally certified medical experts, such as doctor, nurse and therapist, or healthcare personnel or patient under the guidance of qualified medical experts.</li> <li>• The user should also be capable of understanding general machine operation and the content of instruction manual.</li> </ul>																
<b>Intended Patients</b>	This product should not be used by patients, who are unconscious or are not breathing spontaneously.																
<b>Environment</b>	This product is intended for use in a medical facility, such as Hospital, clinic and doctor’s office, and in a room of general household.																
<b>Durable period</b>	<p>Durable periods are as follows, provided the product is used to nebulize saline 10 times a day for 10 minutes each time at room temperature (23°C).</p> <p>Durable period may vary depending on usage environment.</p> <table border="0" style="width: 100%;"> <tr> <td style="padding-right: 20px;">Main unit</td> <td>3 years</td> </tr> <tr> <td>Nebulizer Kit</td> <td>100 days</td> </tr> <tr> <td colspan="2">(Cap, Inhalation Top, Vaporiser Head, Medication Cup)</td> </tr> <tr> <td>Mouthpiece</td> <td>100 days</td> </tr> <tr> <td>Air Tube</td> <td>100 days</td> </tr> <tr> <td>Air Filter</td> <td>60 days</td> </tr> <tr> <td>Adult Mask</td> <td>100 days</td> </tr> <tr> <td>Child Mask</td> <td>100 days</td> </tr> </table>	Main unit	3 years	Nebulizer Kit	100 days	(Cap, Inhalation Top, Vaporiser Head, Medication Cup)		Mouthpiece	100 days	Air Tube	100 days	Air Filter	60 days	Adult Mask	100 days	Child Mask	100 days
Main unit	3 years																
Nebulizer Kit	100 days																
(Cap, Inhalation Top, Vaporiser Head, Medication Cup)																	
Mouthpiece	100 days																
Air Tube	100 days																
Air Filter	60 days																
Adult Mask	100 days																
Child Mask	100 days																
<b>Precautions for use</b>	Warnings and cautions described in the instruction manual should be observed.																

## IMPORTANT SAFETY NOTES

To assure the correct use of the product basic safety measures should always be followed including the precautions listed below:

### **⚠ WARNING:**

Indicates a potentially hazardous situation which, if not avoided, could result in death or serious injury.

#### ***(Usage)***

- For type, dose, and regime of medication follow the instructions of your doctor or respiratory therapist.
- Clean and disinfect the nebulizer kit, mouthpiece and optional nosepiece or masks before using them for the first time after purchase, if the device has not been used for a long period of time.
- If the device is used by more than one person, be sure to clean and disinfect parts before they are used by each person.
- Always dispose of any remaining medication after use, and use fresh medication each time.
- Do not use only water in the nebulizer, for nebulizing purposes.
- Do not use the device where it may be exposed to flammable gas.
- Do not block the ventilation slots. Never place the device where the ventilation slots may be obstructed during operation. Do not cover the compressor with a blanket or towel etc., during use.

#### ***(Risk of electrical shock)***

- Never unplug the power cord with wet hands.
- The compressor and power cord are not waterproof. Do not spill water, or other liquids, on these parts. If liquid does spill on these parts, immediately unplug the power cord and wipe off the liquid with gauze or other absorbent material.
- Do not use or store the device in humid locations, such as a bathroom.
- Do not immerse the main unit in water or other liquid.

Although this device fulfils the provisions of the EMC (Electromagnetic Compatibility) directive, the use of it should be avoided in direct vicinity of other electric devices.

#### ***(Maintenance and Storage)***

- Store the device and accessories in a clean location.
- Always rinse the nebulizing parts with clean hot tap water after disinfecting them. Never leave the cleaning solution in the nebulizing parts.
- Be sure to wash the parts after use, and dry the parts immediately after washing them.
- Keep the device out of the reach of unsupervised infants and children. The device may contain small pieces that can be swallowed.
- Do not store the air tube while there is moisture or medication remaining inside it.

## IMPORTANT SAFETY NOTES

### **⚠ CAUTION:**

Indicates a potentially hazardous situation which if not avoided, may result in minor or moderate injury, or physical damage.

#### ***(Usage)***

- Provide close supervision when this device is used by, on, or near children or invalids.
- Make sure that the vaporiser head, air filter, and other parts are attached correctly.
- Make sure that the air filter is clean. If the air filter has changed colour, or has been used on average for more than 60 days, replace it with a new one.
- Do not tilt the nebulizer kit so that it is at an angle of greater than 45°, or shake it while in use.
- Do not use or store the device while the air tube is bent.
- Approved for human use only.
- Use only original OMRON parts and accessories. Use of unsupported parts may damage the device.
- Do not add more than 7 ml of medication to the medication cup.
- Do not drop the compressor or nebulizer kit, or subject them to strong shocks.
- Do not distort the vaporiser head, or jab the nozzle of the medication cup with a pin etc.
- Do not insert fingers or objects inside the compressor.
- Do not block the air filter cover.
- Do not disassemble or attempt to repair the compressor or power cord.
- To avoid injury to the nose mucosa, do not squeeze the nosepiece into the back of the nose.
- Do not block the slit between the cap and the inhalation air inlet.
- Do not use a microwave oven or hair dryer to dry the nebulizing parts.
- Changes or modifications not approved by OMRON HEALTHCARE will void the user warranty.

#### ***(Risk of electrical shock)***

- Plug the device into the appropriate voltage outlet. Do not overload power outlets or use extension cords.
- Always unplug the device from the power outlet after use.
- Always disconnect the power cord before cleaning.

#### ***(Maintenance and Storage)***

- Do not carry or leave the nebulizer while the medication cup contains medication.
- When sterilizing parts by boiling, make sure that the container does not boil dry.

## IMPORTANT SAFETY NOTES

- Never place, or attempt to dry the compressor, the power cord or nebulizing parts in a microwave oven.

### General Safety Precautions:

- Inspect the device and parts before using the them each time, and check that there are no problems. In particular, be sure to check the following:
  - That the vaporiser head, nozzle or air tube are not damaged.
  - That the nozzle is not blocked.
  - That the compressor operates normally.
- When using this device, there will be some noise and vibration caused by the pump in the compressor. There will also be some noise caused by the emission of compressed air from the nebulizer kit. This is normal and does not indicate a malfunction, or reduce the working life of the device.
- Operate the device only as intended. Do not use the device for any other purpose.
- Do not use the device at temperatures greater than +40°C.
- Dispose of the device and any used accessories or optional parts according to applicable local regulations. Unlawful disposal may cause environmental pollution.

# KNOW YOUR UNIT

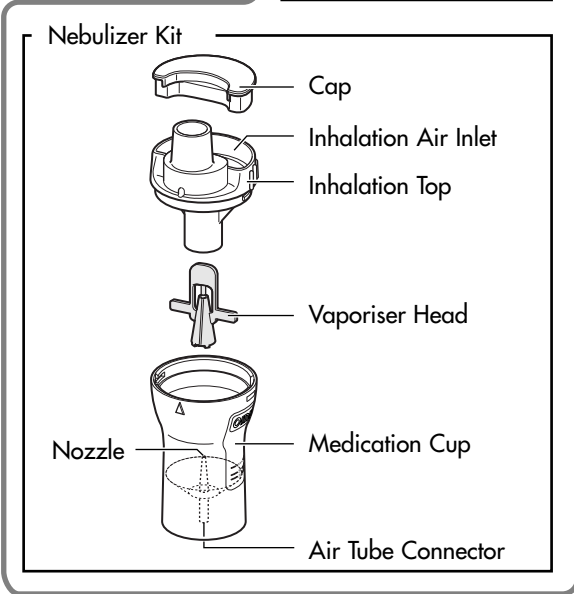
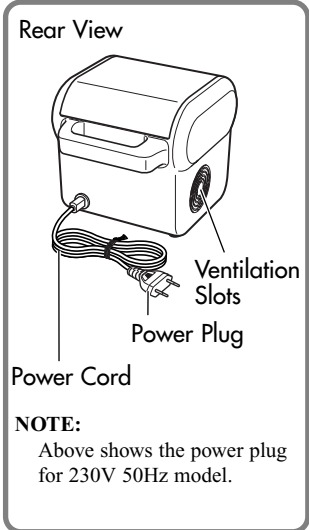
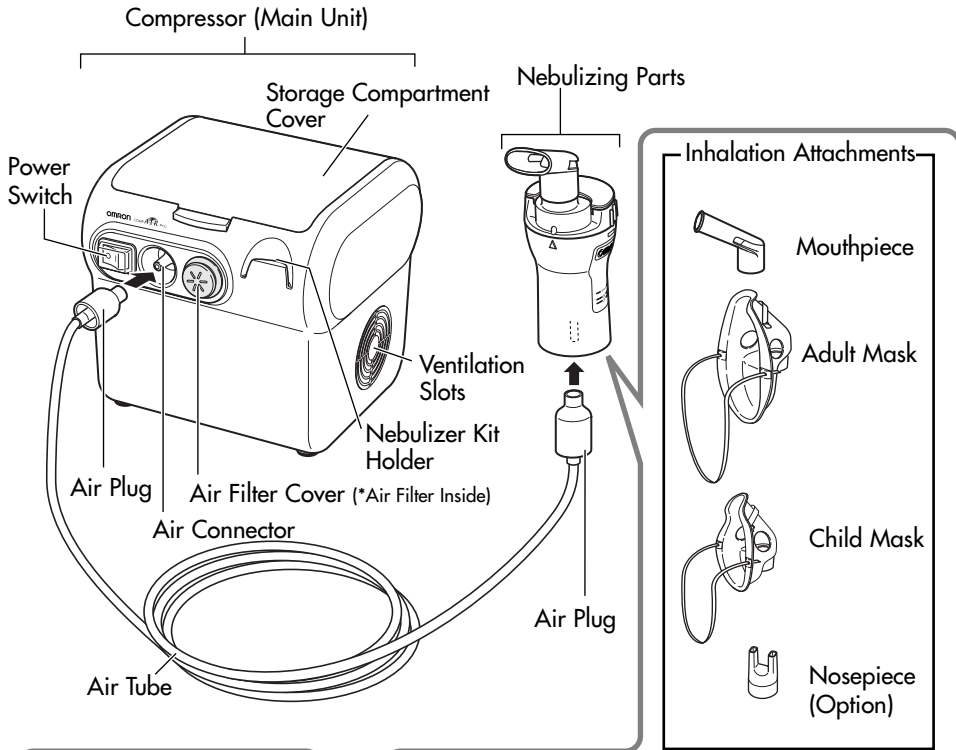

# KNOW YOUR UNIT

## Accessories:

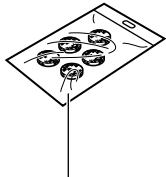

Spare Air Filters x 5

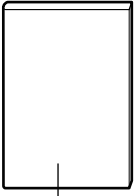

Instruction Manual



## GUIDE TO USING THE NE-C29

### HOW TO PREPARE THE NEBULIZER FOR USE (Page 9)

#### NOTE:

Clean and disinfect the nebulizer kit and applicable inhalation attachments before using the device for the first time, or if it has not been used for a while.



### HOW TO TAKE MEDICATION (Page 13)

#### NOTES:

- Do not tilt the nebulizer kit so that it is at an angle of greater than 45°.
- Do not bend or fold the air tube.

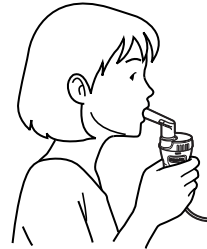

### HOW TO CLEAN PARTS AFTER USE (Page 16)

#### NOTE:

Failure to clean the nebulizing parts after use may lead to infection.

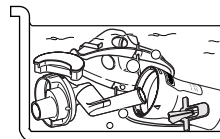

### HOW THE NEBULIZER KIT WORKS

The medication that is pumped up through the medication channel is mixed with compressed air which is generated by a compressor pump. The compressed air mixed with medication is turned into fine particles and sprayed by being impacted to the baffle.

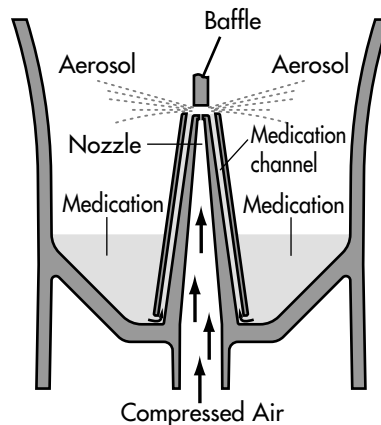

## HOW TO PREPARE THE NEBULIZER FOR USE

### ⚠ WARNING:

**Clean and disinfect the nebulizer kit, mouthpiece and optional nosepiece or masks before using them for the first time after purchase, if the device has not been used for a long period of time.**

For directions on cleaning and disinfecting the parts of the device refer to page 16 in this instruction manual.

### NOTE:

Make sure that the air filter is changed regularly. (See “How to Change the Air Filter” on page 19.)

1. Make sure that the power switch is turned off.

Check that the power switch is in the  position.

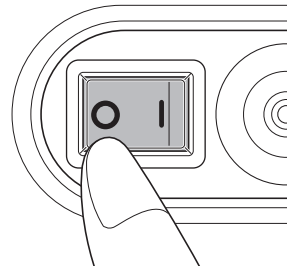

2. Plug the power plug into a power outlet.

3. Remove the mouthpiece and cap from the nebulizer kit.

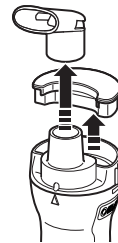

4. Remove the inhalation top from the medication cup.
  - 1) Rotate the inhalation top counter clockwise.
  - 2) Lift the inhalation top out of the medication cup.

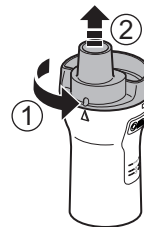

## HOW TO PREPARE THE NEBULIZER FOR USE

5. Remove the vaporiser head from the medication cup.



6. Add the correct amount of prescribed medication to the medication cup.

**⚠ CAUTION:**

**The capacity of the medication cup is  
2 to 7 ml.**



7. Reattach the vaporiser head to the medication cup.



8. Put the inhalation top back inside the medication cup.

- 1) Align the protrusion on the inhalation top with the indent on the medication cup, as shown.
- 2) Rotate the inhalation top clockwise and align with the medication cup until they click in place.

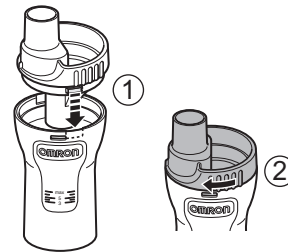

# HOW TO PREPARE THE NEBULIZER FOR USE

9. Attach the desired inhalation attachment, as described below.

Attach the cap when using the mouthpiece or optional nosepiece. Using the cap with these attachments will reduce the amount of medication that is discharged into the air.

***Attaching the Mouthpiece***

- 1) Attach the cap to the inhalation air inlet.
- 2) Attach the mouthpiece to the inhalation top.

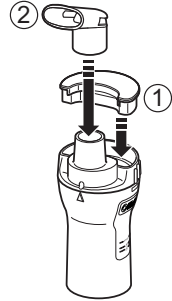

***Attaching the Adult Mask***

Attach the mask to the inhalation top.

**NOTE:**

Do not attach the cap.

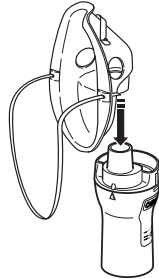

***Attaching the Child Mask***

Attach the mask to the inhalation top.

**NOTE:**

Do not attach the cap.

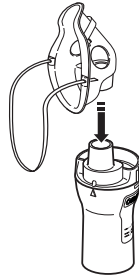

***Attaching the Nosepiece (Option)***

- 1) Attach the cap to the inhalation air inlet.
- 2) Attach the nosepiece to the inhalation top.

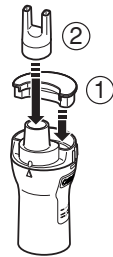

## HOW TO PREPARE THE NEBULIZER FOR USE

### 10. Attach the air tube.

- 1) Attach the air tube to the air connector on the compressor.
- 2) Attach the other end of the air tube to the air tube connector on the medication cup.

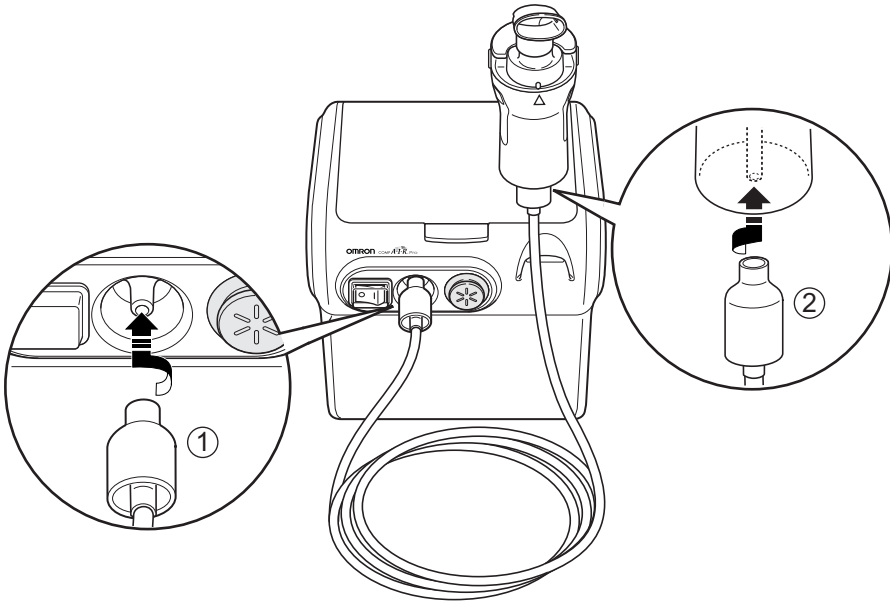

### NOTES:

- Make sure that the air tube is securely connected. Otherwise, air may leak from the air tube during use.
- Take care not to spill the medication when attaching the air tube. Keep the nebulizer kit upright.
- Use the nebulizer kit holder as a temporary holder for the nebulizer kit.

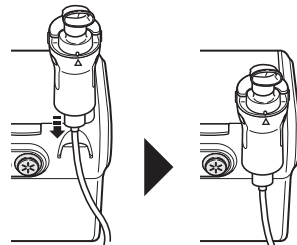

## HOW TO TAKE MEDICATION

1. Hold the nebulizer kit as indicated on the right.

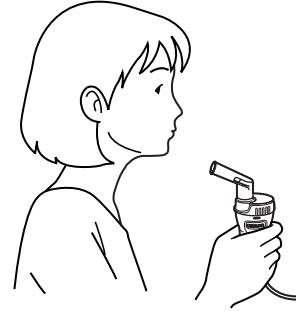

**⚠ CAUTION:**

**Do not tilt the nebulizer kit so that it is at an angle of greater than 45°. Medication may flow into the mouth.**

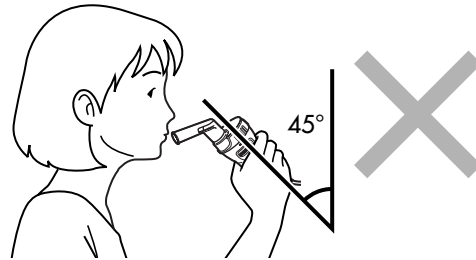

2. Press the power switch to the on (I) position.

The compressor starts and nebulization starts.

**NOTE:**

Perform functional test, observe whether aerosol is generated.

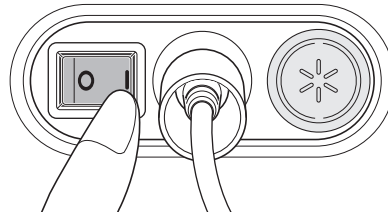

***To stop nebulization***

Press the power switch to the off (O) position.

**⚠ WARNING:**

**Do not block the ventilation slots on the compressor. This could result in the compressor overheating or malfunctioning.**

**⚠ CAUTION:**

**Do not block the air filter cover.**

## HOW TO TAKE MEDICATION

3. Inhale medication as according to your doctor's and/or health care adviser's instructions.

### *Using the Mouthpiece*

Insert the mouthpiece into your mouth and inhale the medication breathing normally. Exhale as normal through the mouthpiece.

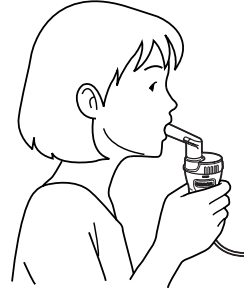

### *Using the Adult Mask*

Attach the mask so that it covers your nose and mouth and inhale the medication. Exhale as normal through the mask.

#### **NOTE:**

If the amount of aerosol is too great, attach the cap.

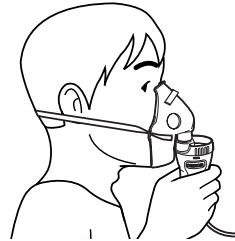

### *Using the Child Mask*

Attach the mask so that it covers your nose and mouth and inhale the medication. Exhale as normal through the mask.

#### **NOTE:**

If the amount of aerosol is too great, attach the cap.

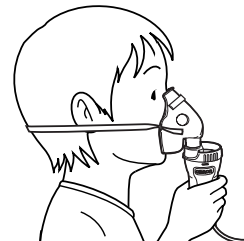

### *Using the Nosepiece (Option)*

Inhale the medication through the nosepiece, as shown and exhale through the mouth.



## HOW TO TAKE MEDICATION

### 4. Complete your treatment.

- 1) When you have finished inhaling your medication, turn the compressor off.

Press the power switch to the off  position.

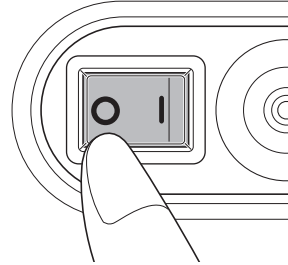

- 2) Unplug the air tube from the nebulizer kit.

**NOTE:**

Always hold the air plug when disconnecting the air tube.

- 3) Check that there is no condensation or moisture remaining in the air tube.

**If there is moisture or liquid remaining in the air tube, be sure to follow the procedure below to remove any moisture from within the air tube.**

- i) Make sure that the air tube is still connected to the air connector on the compressor.
- ii) Turn on the compressor and pump air through the air tube to expel the moisture.

- 4) Unplug the air tube from the compressor.

** WARNING:**

**Condensation may occur in the air tube. Do not store the air tube while it contains condensation or moisture. This could result in infection via bacteria.**

- 5) Unplug the device from the power outlet.



## CLEANING AND DAILY DISINFECTING

Following the cleaning instructions after each use will prevent any remaining medication in the bottle from drying resulting in the device not nebulizing effectively and also for preventing infections.

### **⚠ WARNING:**

**Be sure to wash the parts after use, and dry the parts immediately after washing them.**

1. Remove the nebulizer kit from the air tube and disassemble the nebulizer kit.  
Separate the inhalation attachment and the nebulizer kit, and disassemble the nebulizer kit. (See page 9)
2. Discard any remaining medication in the medication cup.

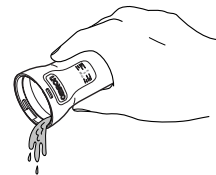

3. Wash all the parts of the nebulizing parts in warm water and mild detergent, or wash in a dishwasher.  
For instructions on how to disinfect the parts, see the following section.
4. After cleaning and disinfecting the parts, rinse them thoroughly with clean water and allow the parts to air dry in a clean environment.

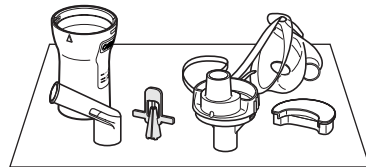

### **Disinfecting the Parts of the Nebulizing Parts**

Always disinfect the medication cup, mouthpiece and other parts of the nebulizing parts after the last treatment of the day. To disinfect the parts, use one of the methods described below:

- A.** Use a commercially available disinfectant. Follow the instructions provided by the disinfectant manufacturer.
- B.** Parts may be boiled for more than 15 minutes (except for mask).
  1. Submerge the parts in the cleansing solution for the specified period.
  2. Remove the parts and discard the solution.
  3. Rinse the parts with clean hot tap water.

# MAINTENANCE AND STORAGE

1. Assemble the nebulizing parts.
2. If the compressor is dirty, wipe it clean with a soft cloth moistened with water or mild detergent.

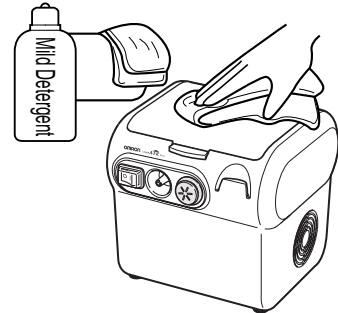

**⚠ WARNING:**

**The compressor is not waterproof.**

3. If the outside of the air tube is dirty, wipe it clean with a soft cloth moistened with water or mild detergent.
4. Store the parts in the storage compartment in the compressor.

**NOTE:**

Make sure that the parts are clean and dry. Do not place parts in the storage compartment if they are still wet.

5. Store the unit in a clean location.

**NOTE:**

Nebulizer kit should be replaced after using for 6 months.

**Handling the Vaporiser Head**

The vaporiser head is an important part that is used to vaporise medication. Be sure to observe the following precautions when handling it.

**⚠ CAUTION:**

- **Always wash the vaporiser head after each use.**
- **Do not use a brush or pin etc., to clean the parts.**
- **When disinfecting the parts by boiling, be sure to boil them in plenty of water.**
- **Do not boil vaporiser head together with other objects, other than applicable nebulizer accessories.**
- **Do not use a microwave oven, dish dryer or hair dryer to dry parts.**

## MAINTENANCE AND STORAGE

To keep your device in the best condition and protect the device from damage follow these directions:

### **⚠ CAUTION:**

- **Do not drop the compressor or nebulizer kit, or subject them to strong shocks.**
- **Do not carry or leave the nebulizer while the medication cup contains medication.**

### **NOTES:**

- Do not store the device in extreme hot or cold temperatures, high humidity or under direct sunlight.
- Dispose of the device and any used accessories or optional parts according to applicable local regulations.
- Never clean with benzene, thinner or a flammable chemical.



## HOW TO CHANGE THE AIR FILTER

If the air filter becomes dirty, or has water or medication spilled on it, replace the air filter with a new one. On average, the air filter should be changed every 60 days even if it does not appear dirty.

1. Pull the air filter cover off the compressor.

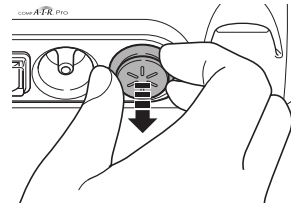

2. Change the air filter.

Remove the old air filter with a sharp object, such as a toothpick, and insert the new air filter.

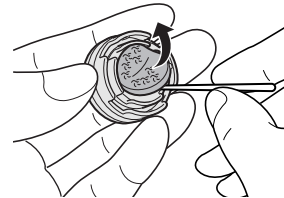

3. Put the air filter cover back in place.

### NOTES:

- Use only OMRON air filters designed for this unit. Do not operate without a filter.
- There is no front or back orientation for the air filters.
- Check that air filters are clean and free of dust before inserting them.
- Do not attempt to wash or clean the filter. If the air filter becomes wet, replace it. Damp air filters can cause blockages.
- To prevent the mesh of the air filter cover becoming blocked, wash the cover regularly. Do not boil the air filter cover. Remove the air filter cover, wash it, and make sure it is dry and reattached correctly.
- Please contact your OMRON dealer for additional air filters, or if the parts supplied with the device are damaged or missing.

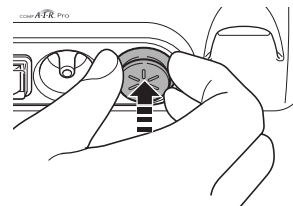

# TROUBLESHOOTING TIPS

Check the following if your unit should fail during operation. You can also refer to the pages of this manual for complete instructions.

PROBLEM	CAUSE	REMEDY
Nothing happens when the power switch is pressed.	Is the power plug plugged into an electrical outlet?	Check that the plug is inserted in an electrical outlet. Unplug then reinsert the plug if necessary.
No nebulization or low nebulization rate, when the power is on.	Is there medication in medication cup?	Fill the medication cup.
	Is there too much/little medication in the medication cup?	Add the correct amount of medication to the medication cup.
	Is the vaporiser head missing and not assembled correctly?	Attach the vaporiser head correctly.
	Is the nebulizer kit assembled correctly?	Assemble the nebulizer kit correctly.
	Is the nozzle blocked?	Make sure that the nozzle is free of blockages.
	Is the nebulizer kit tilted at a sharp angle?	Make sure that the nebulizer kit is not tilted at an angle of more than 45 degrees.
	Is the air tube connected correctly?	Make sure that the air tube is correctly connected to the compressor and nebulizer kit.
	Is the air tube folded or damaged?	Make sure that the air tube does not contain kinks.
	Is the air tube blocked?	Make sure that the air tube is free of blockages.
Is the air filter dirty?	Replace the air filter with a new one.	
The device is abnormally loud.	Is the air filter cover attached correctly?	Attach the air filter cover correctly.
The device is very hot.	Are the ventilation slots blocked?	Do not block the ventilation slots.

**NOTES:**

- If the suggested remedy does not solve the problem, do not try to repair the device - no parts of the unit are user serviceable. Return the unit to an authorized OMRON dealer.
- The device should be serviced once a year by an approved OMRON service centre.

## SPECIFICATIONS

<b>Model:</b>	NE-C29
<b>Type:</b>	Compressor Nebulizer
<b>Electrical:</b>	230V, 50Hz model ; 230V, 60Hz model
<b>Power Consumption:</b>	138VA
<b>Operating Temperature/ Humidity:</b>	+10°C to +40°C, 30% to 85% RH
<b>Storage Temperature/ Humidity:</b>	-20°C to +60°C, 10% to 95% RH
<b>Weight:</b>	Approx. 2.3kg (compressor only)
<b>Dimensions:</b>	Approx. 186mm (w) × 180mm (h) × 216mm (d)
<b>Contents:</b>	Compressor, Nebulizer Kit, Air Tube, 5 pcs Replacement Filters, Mouthpiece, Adult Mask, Child Mask, Instruction Manual.

### NOTES:

- Subject to technical modification without prior notice.
- Please note that specifications may vary with medication type used.
- Do not use the device where it may be exposed to flammable gas.
- This unit fulfils the provisions of the EC directive 93/42/EEC (Medical Device Directive) and the European Standard EN13544-1:2007, Respiratory therapy equipment - Part1: Nebulizing systems and their components.
- This OMRON product is manufactured under the strict quality system of OMRON HEALTHCARE Co., Ltd., Japan.

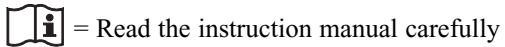
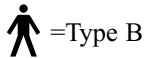
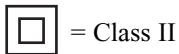

**CE 0197**

# SPECIFICATIONS

**Technical data for the OMRON Comp Air Pro compressor with the OMRON V.V.T. (Virtual Valve Technology) Nebulizer kit:**

<b>Particle Size:</b>	*MMAD **approximately 3µm
<b>Medication Tank Capacity:</b>	7 ml maximum
<b>Appropriate Medication Quantities:</b>	2 ml minimum - 7 ml maximum
<b>Sound:</b>	Noise level (at 1 m distance) 60 db
<b>Nebulization Rate:</b>	0.4 ml/min (by weight loss)
<b>Aerosol Output:</b>	**0.4 ml (2ml, 1%NaF)
<b>Aerosol Output Rate:</b>	**0.06 ml/min (2ml, 1%NaF)

**NOTES:**

- Performance may vary with drugs such as suspensions or high viscosity. See drug supplier’s data sheet for further details.
- The data above is referenced by OMRON HEALTHCARE.
- See web site of OMRON HEALTHCARE EUROPE to update technical information.

Result of cascade impactor \*\*measurements for particle size with OMRON Comp Air Pro compressor and OMRON V.V.T. Nebulizer kit

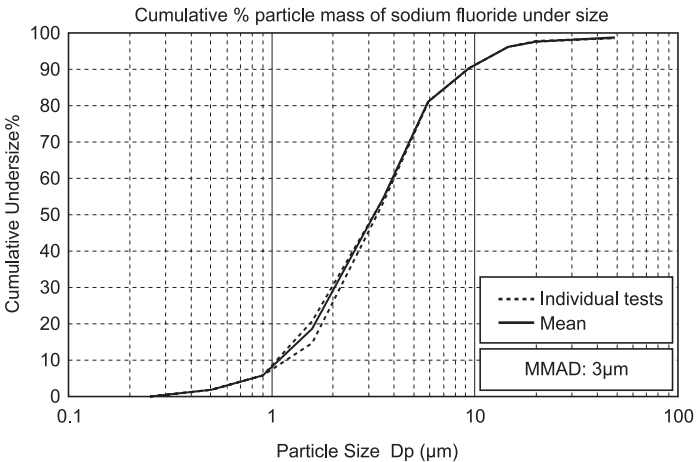

\* MMAD = Mass Median Aerodynamic Diameter

\*\* Independently measured at SolAero Ltd., Canada, Dr. John Dennis, according to EN 13544-1

## SPECIFICATIONS

### ***Important information regarding Electro Magnetic Compatibility (EMC)***

With the increased number of electronic devices such as PC's and mobile (cellular) telephones, medical devices in use may be susceptible to electromagnetic interference from other devices. Electromagnetic interference may result in incorrect operation of the medical device and create a potentially unsafe situation.

Medical devices should also not interfere with other devices.

In order to regulate the requirements for EMC (Electro Magnetic Compatibility) with the aim to prevent unsafe product situations, the EN60601-1-2:2007 standard has been implemented. This standard defines the levels of immunity to electromagnetic interferences as well as maximum levels of electromagnetic emissions for medical devices.

This medical device manufactured by OMRON HEALTHCARE conforms to this EN60601-1-2:2007 standard for both immunity and emissions.

Nevertheless, special precautions need to be observed:

- Do not use mobile (cellular) telephones and other devices, which generate strong electrical or electromagnetic fields, near the medical device. This may result in incorrect operation of the unit and create a potentially unsafe situation. Recommendation is to keep a minimum distance of 7 m. Verify correct operation of the device in case the distance is shorter.

Further documentation in accordance with EN60601-1-2:2007 is available at OMRON HEALTHCARE EUROPE at the address mentioned in this instruction manual.

Documentation is also available at [www.omron-healthcare.com](http://www.omron-healthcare.com).



## SPECIFICATIONS



### *Correct Disposal of This Product (Waste Electrical & Electronic Equipment)*

This marking shown on the product or its literature, indicates that it should not be disposed of, with other household wastes at the end of its working life. To prevent possible harm to the environment or human health from uncontrolled waste disposal, please separate this from other types of wastes and recycle it responsibly to promote the sustainable reuse of material resources.

Household users should contact either the retailer where they purchased this product, or their local government office, for details of where and how they can take this item for environmentally safe recycling.

Business users should contact their supplier and check the terms and conditions of the purchase contract. This product should not be mixed with other commercial wastes for disposal.

This product does not contain any hazardous substances.

# OPTIONAL PARTS AND ACCESSORIES

**Nebulizer Kit Set**  
Model No. C28NEBKIT  
Nebulizer Kit

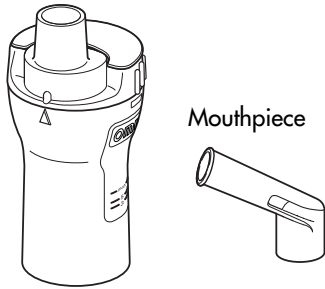

**Nosepiece**  
Model No. C28NP



**Air Tube**  
Model No. C30TUBE

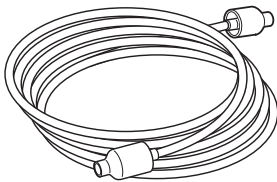

**Mouthpiece**  
Model No. C28MP



**Filter Cover**  
Model No. C28FLCVR



**Adult Mask**  
Model No. C28AM

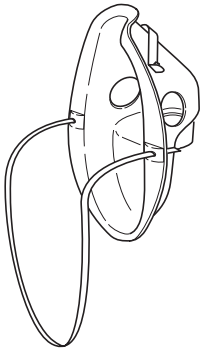

**Child Mask**  
Model No. C28CM

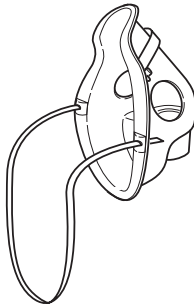

**Air Filters (x 5)**  
Model No. C28FL

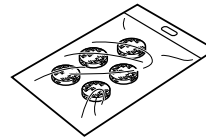

OMRON®

# 使用說明書

COMP *A-I-R*™ Pro

## Compressor Nebulizer System

### 壓縮藥物噴霧器

Model  
型號 **NE-C29**

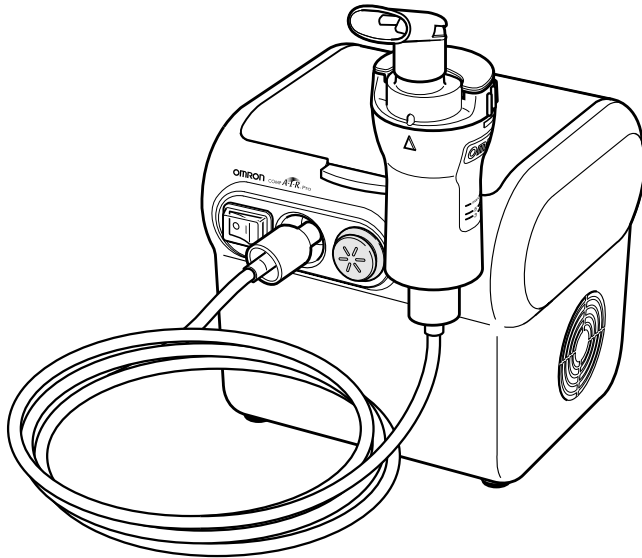

All for Healthcare

# 目錄

## 使用前須知

重要安全信息 .....	2
瞭解機器 .....	4
NE-C29 使用指南 .....	6

## 操作說明

使用噴霧器應做何準備 .....	7
如何使用藥物 .....	11

## 保養和維修

清潔並每日消毒 .....	14
保養和存放 .....	15
如何更換空氣過濾片 .....	16
疑難排解注意事項 .....	17
規格 .....	18
任選部件及附件 .....	19

## 重要安全信息

為確保正確使用產品，請務必遵循基本安全措施，包括下列預防措施：

### 危險：

指明潛在的危險情況，如果無法避免這些情況發生，可能導致死亡或嚴重傷害。

### (使用)

- ☑ 有關放入藥物的類型、劑量和配製方法，請遵循醫師或呼吸道治療師。
- ☑ 購買噴霧杯、口含配件、任選鏡鼻或面罩後首次使用之前，請將其進行清潔和消毒，如果長期未使用或多人共用一設備，應給產品消毒。
- ☑ 如果設備不止一人使用，請在每個人使用之前，確保設備部件得到清潔和消毒。
- ☑ 務必在使用後處理掉任何殘留藥劑，並且每次都要使用新藥劑。
- ☑ 若實現噴霧效果，請勿在噴霧器中僅使用水。
- ☑ 使用設備時，請勿將其暴露於易燃性氣體之下。
- ☑ 切勿阻塞通風槽。操作時切勿將設備置於通風槽可能被阻塞的區域。使用時切勿使用毯子或毛巾等遮蓋壓縮機。

### (當心觸電)

- ☑ 切勿用濕手拉扯電源線。
- ☑ 壓縮機和電源線均不防水。切勿將水或其他液體潑濺這些部件之上。如果液體潑濺於這些部件之上，請立即拔下電源線，然後使用紗布或其他吸收性材料擦去液體。
- ☑ 請勿在諸如浴室等潮濕場所中使用或儲存裝置。
- ☑ 切勿將機器浸於水中或其他液體內。

儘管本設備符合 EMC（電磁相容）指令的規定，但使用本設備時還是應避免與其他電子設備直接相鄰。

### (保養和存放)

- ☑ 將設備和附件儲藏在乾淨的場所。
- ☑ 噴霧杯部件消毒完畢後，務必使用熱水將其沖洗乾淨。切勿讓清潔溶液殘留於藥物杯或口含配件中。
- ☑ 確保使用後清潔部件，同時確保其經過徹底風干。
- ☑ 機器應保存在嬰兒或兒童無法觸及的地方。由於設備包含可被吞咽的為小部件。
- ☑ 氣管中仍有殘留液體或藥物時，請勿將其儲藏。

## 重要安全信息

### **⚠ 警告：**

表示潛在的危險情況，如果無法避免這些情況發生，可能導致輕度或中度傷害，或引起身體傷害。

### **(使用)**

- 使用于兒童或殘疾人，或由兒童或殘疾人使用，或在有兒童或殘疾人的場所使用時，須嚴密監控。
- 確保折流板、空氣過濾片和其他部件連接正確。
- 確保空氣過濾片乾淨。如果空氣過濾片已變色，或已平均使用超過 60 天，請用新的過濾片予以更換。
- 切勿讓噴霧杯的傾斜角度超過 45°，或在使用過程中搖動。
- 氣管彎曲時請勿使用或儲藏設備。
- 僅限人類使用。
- 請僅使用 OMRON 原裝部件和附件。使用不受支持的部件可能損壞裝置。
- 切勿在藥物杯內加入超過 7 毫升的劑量。
- 不要摔扔壓縮機或噴霧杯，或使其受到猛烈震動。
- 不要使折流板變形，或使用大頭針等物件刺戳藥物杯噴嘴。
- 不要將手指或物件插入壓縮機內。
- 切勿阻塞空氣過濾蓋。
- 切勿拆卸或試圖修理壓縮機或電源線。
- 請勿將吸氣鏡鼻塞進鼻孔後面，以免損傷鼻粘液膜。
- 請勿阻塞噴霧杯蓋與吸氣入口的孔口。
- 請勿使用微波爐或吹風機弄干噴霧部件。
- 未經 OMRON Healthcare 認可更換或維修機器會令用戶保修失效。

### **(當心觸電)**

- 設備必須與電壓與本型號適合的插座連接。不要使電源插座負載或使用延長線。
- 使用後務必將設備從電源插座上拔下。
- 清潔前務必拔下電源線。

### **(保養和存放)**

- 藥物杯內有藥物時，請勿挾帶或離開噴霧杯。
- 使用蒸煮方式消毒部件時，確保容器不會煮干。
- 切勿將壓縮機、電源線或噴霧器置於微波爐中，或試圖在微波爐中將它們烘干。

### **一般安全注意事項：**

- 每次使用裝置和部件前請對其進行檢查，並確保無任何問題存在。特別要注意下列情況：
  - 折流板、噴嘴或氣管未損壞。
  - 噴嘴未阻塞。
  - 壓縮機運行正常。
  - 壓縮機操作正常。
- 使用本設備時，壓縮機中的氣泵會產生一些雜訊和振動。同時，噴霧杯中壓縮空氣釋放也會引起雜訊。這屬於正常情況，並不是故障，或縮短其工作壽命。
- 此產品只適用於指定的用途。切勿用作其他用途。
- 溫度超過 +40°C 時切勿使用本設備。
- 依照當地的規例處置裝置及任何使用過的附件或替換部件。違規處置可能會引起環境污染。

# 瞭解機器

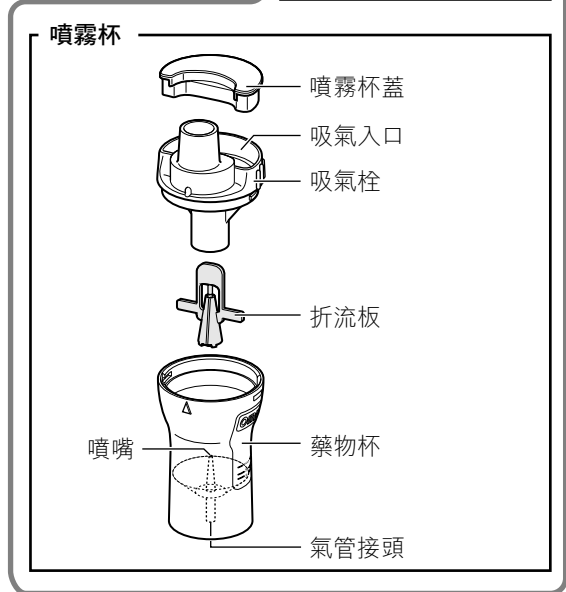
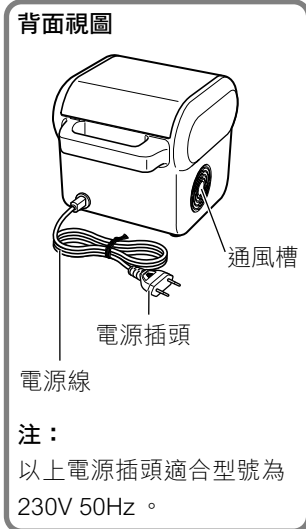
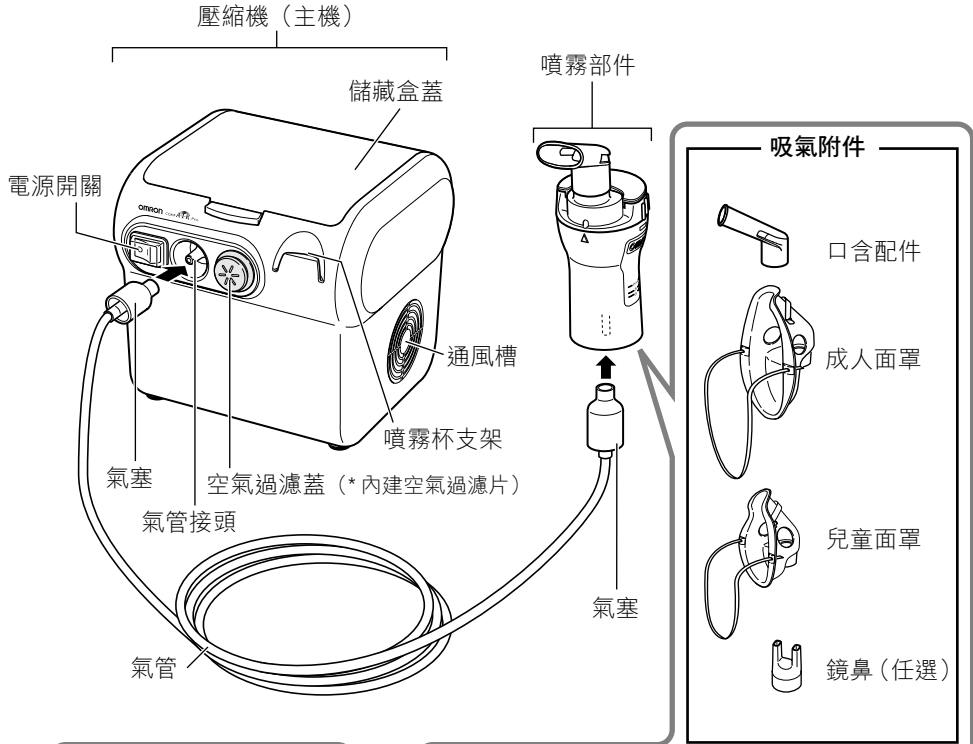

# 瞭解機器

附件：

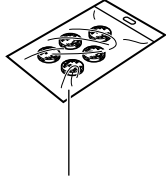

5 個備用空氣過濾片



使用說明書



## NE-C29 使用指南

### 使用噴霧器應做何準備（見頁 7）

注：

第一次使用前或長時間未用時，請對噴霧杯及適用吸氣附件清潔和消毒。



### 如何使用藥物（見頁 11）

注：

- 不要使噴霧杯傾斜角度大於 45°。
- 不要彎曲或折疊氣管。

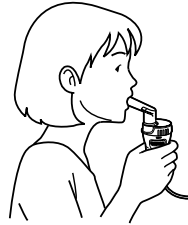

### 使用後如何清潔部件（見頁 14）

注：

使用後未清潔噴霧部件可能會導致感染。

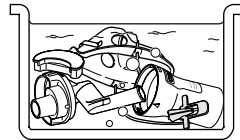

### 噴霧杯操作原理

空氣經壓縮機壓縮後通過噴嘴，同時在折流板內與藥物相混合，並在壓力下繼續向上運動。藥物此時轉化為細小的氣霧劑，沿著折流板向上運動，最後分裂為許多更小的氣霧粒子。

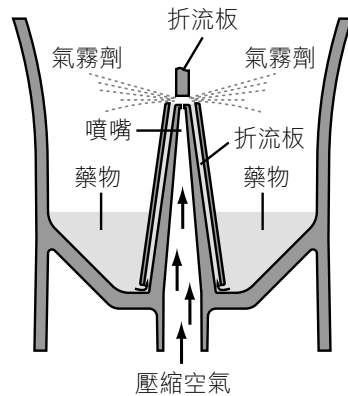

## 使用噴霧器應做何準備

### ⚠ 警告：

第一次使用前或長時間未用時，請對噴霧杯、口含配件及任選鏡鼻或面罩清潔和消毒。

有關裝置部件清潔和消毒的指導，請參閱本說明書的第 14 頁。

### 注：

確保定期更換空氣過濾片。（請參閱第 16 頁「如何更換空氣過濾片」。）

1. 確保電源開關已關閉。確保電源開關處在 ○ 位置。

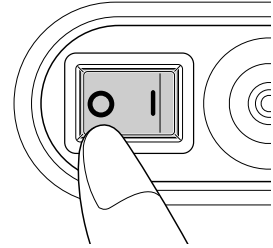

2. 將電源插頭插入電源插座。

3. 從噴霧杯上拆下口含配件及噴霧杯蓋。

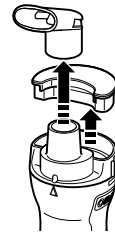

4. 從藥物杯中取下吸氣栓。

- 1) 逆時針旋轉吸氣栓。
- 2) 從藥物杯中取出吸氣栓。



## 使用噴霧器應做何準備

5. 從藥物杯中拆下折流板。



6. 往藥物杯內添加適當劑量的處方藥。

**⚠ 注意：**  
藥物杯容量為 2 到 7 毫升。



7. 將折流板重新連接到藥物杯中。



8. 將吸氣栓放回藥物杯中。

- 1) 如圖所示，將吸氣栓上突出部分與藥物杯縮進部分對齊。
- 2) 將吸氣栓與藥物杯對齊並順時針旋轉，直至發出「喀卡」聲響就位。

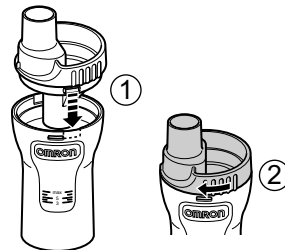

## 使用噴霧器應做何準備

9. 如下所述，將所需吸氣附件連接到位。

使用口含配件或任選鏡鼻時，請連接噴霧杯蓋。將噴霧杯蓋與這些附件搭配使用將減少藥物在空氣中的洩漏量。

### 連接口含配件

- 1) 將噴霧杯蓋連接到吸氣入口。
- 2) 將口含配件連接到吸氣柱。

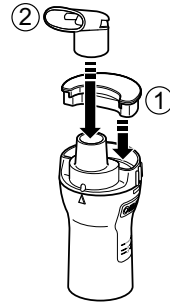

### 連接成人面罩

將面罩連接到吸氣柱。

注：

不要連接噴霧杯蓋。

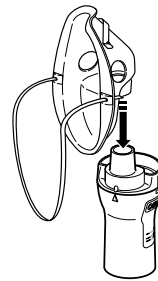

### 連接兒童面罩

將面罩連接到吸氣柱。

注：

不要連接噴霧杯蓋。

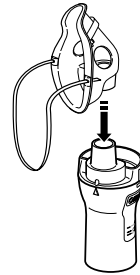

### 連接鏡鼻（任選）

- 1) 將噴霧杯蓋連接到吸氣入口。
- 2) 將鏡鼻連接到吸氣柱。

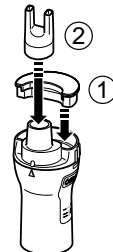

## 使用噴霧器應做何準備

10. 連接氣管。

- 1) 將氣管連接到壓縮機上的氣管接頭。
- 2) 將氣管的另一端連接到藥物杯上的氣管接頭。

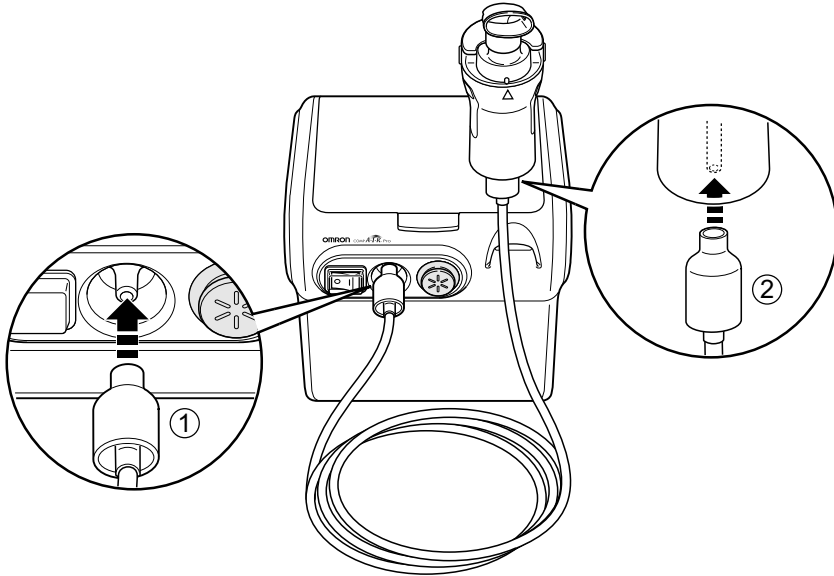

注：

- 確保氣管連接正確。否則，使用時氣體會從氣管洩漏。
- 連接氣管時慎防藥物潑濺。保持噴霧杯垂直。
- 噴霧杯支架可用做噴霧杯臨時支架。

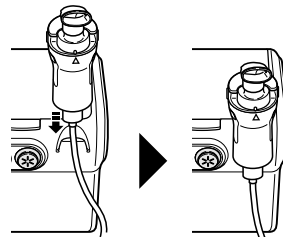

## 如何使用藥物

1. 如右圖所示，握住噴霧杯。

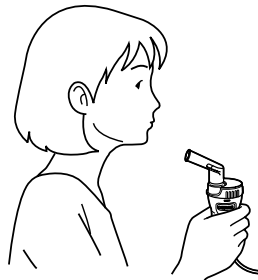

- ⚠ 注意：**  
不要使噴霧杯傾斜角度大於 45°。  
藥物可能流入口中。

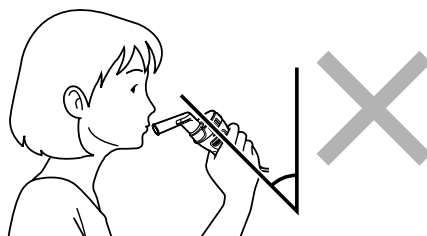

2. 按下電源開關，使其位於開啟 ( I ) 位置。  
壓縮機啟動，噴霧開始。

- 注：**  
執行功能測試，觀察是否生成氣霧。

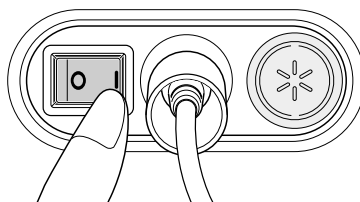

### 要停止噴霧

- 按下電源開關，使其位於開啟 ( O ) 位置。

- ⚠ 警告：**  
切勿阻塞壓縮機上的通風槽。否則可能導致壓縮機過熱或出現故障。

- ⚠ 注意：**  
切勿阻塞空氣過濾蓋。

## 如何使用藥物

3. 按醫師和 / 或健康顧問的指示吸入藥物。

### 使用口含配件

將口含配件插入口中，在正常呼吸情況下吸入藥物。使用口含配件正常呼氣。

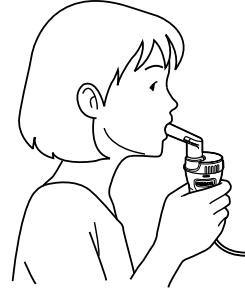

### 使用成人面罩

連接面罩，並罩住鼻子及口部，然後吸入藥物。使用面罩正常呼氣。

注：

若氣霧分量過大，請連接噴霧杯蓋。

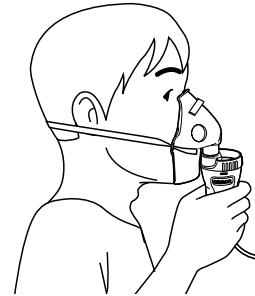

### 使用兒童面罩

連接面罩，並罩住鼻子及口部，然後吸入藥物。使用面罩正常呼氣。

注：

若氣霧分量過大，請連接噴霧杯蓋。



### 使用鏡鼻（任選）

如圖所示，透過鏡鼻吸入藥物，透過嘴巴呼氣。



## 如何使用藥物

### 4. 治療完畢。

- 1) 藥物吸入完成後，請關閉壓縮機。  
按下電源開關，使其位於關閉 ○ 位置。

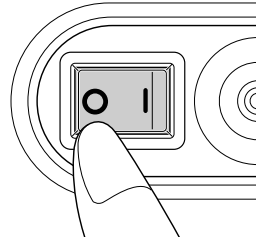

- 2) 從噴霧杯拔下氣管。  
**注：**  
斷開氣管時，務必握住氣塞。
- 3) 請檢查氣管內是否有殘留凝結物或水份。

**若氣管內有殘留水份或液體，請務必遵循下列步驟，以完全清除氣管內水份。**

- i) 確保氣管仍然與壓縮機上氣管接頭相連。
- ii) 開啟壓縮機，然後使用氣泵從氣管抽氣，排出水份。

- 4) 從壓縮機拔下氣管。

**⚠ 警告：**

氣管內可能出現凝結物。氣管內有殘留凝結物或水份時，請勿將其儲存。這可能導致因細菌引發感染。

- 5) 從電源插座上拔下裝置。



## 清潔並每日消毒

每次使用後應遵循清潔指導清潔產品，這可以防止殘留藥劑在容裝瓶內乾燥，從而影響設備的噴霧效能，同時也可防止感染。

### 警告：

**務必使用後清洗相關部件，並在清洗後迅速晾乾。**

1. 從氣管上取下噴霧杯，並將其拆卸。分離吸氣附件與噴霧杯，並拆卸噴霧杯。（參閱第 7 頁）。
2. 倒掉藥物杯中的殘留藥劑。

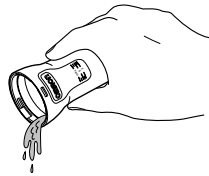

3. 在溫水中使用柔和清潔劑清洗噴霧部件的各個部分，或直接使用洗碗機清洗。有關如何消毒部件的說明，請參閱以下部分。
4. 完成部件的清潔和消毒操作後，請使用清水徹底清洗，並在潔淨環境中晾乾。

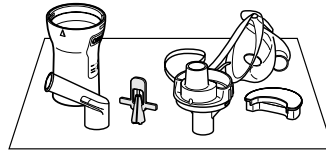

### 噴霧部件各個部分的消毒處理

完成每日的最後一次療用後，需要將藥物杯、口含配件以及其他部件進行消毒處理。要進行消毒處理，請使用以下方法之一：

- A. 使用市場上提供的藥物消毒劑。請遵循藥物消毒劑製造商提供的使用說明。
- B. 將各部件（面罩除外）放入開水中煮沸 15 分鐘以上。
  1. 將各部件浸沒在清潔溶劑中，並浸泡指定的時間。
  2. 取出已消毒的部件，排除廢液。
  3. 用乾淨的熱水沖洗已消毒的部件。

## 保養和存放

1. 組裝噴霧部件。
2. 如果壓縮機不乾淨，請使用軟抹布浸水或柔和清潔劑將其擦拭乾淨。

**⚠ 警告：**  
壓縮機不具備防水功能。

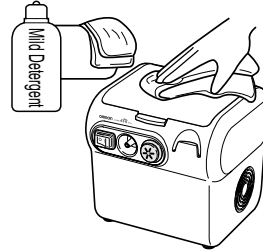

3. 如果氣管外部不乾淨，請使用軟抹布浸水或柔和清潔劑將其擦拭乾淨。
4. 將部件儲藏在壓縮機的儲藏盒內。  
**注：**  
確保部件清潔及乾燥。如果部件潮濕，切勿將其儲藏在儲藏盒內。

5. 請將設備儲藏在乾淨場所。  
**注：**  
使用 6 個月後，應更換噴霧杯。

要保證設備處於最佳工作狀態，並免於損壞，請遵循以下指示：

- ⚠ 注意：**
- 不要摔扔壓縮機或噴霧杯，或使其受到猛烈震動。
  - 藥物杯內有藥物時，請勿攜帶或離開噴霧杯。

- 注：**
- 切勿將設備儲藏在極端高溫、低溫、高濕環境，並避免日光直射。
  - 依照當地的規例處置裝置及任何使用過的附件或替換部件。
  - 切勿使用苯、稀釋劑或易燃化學藥品清潔噴霧器部件。



## 如何更換空氣過濾片

如果空氣過濾片不乾淨，或者在其上面有水或藥劑濺溢，請用新的空氣過濾片予以更換。平均每 60 天要更換一次空氣過濾片，即使其看起來並不髒。

1. 從壓縮機上取下空氣過濾蓋。

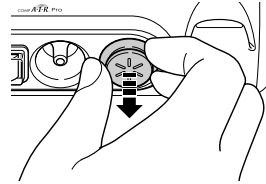

2. 更換空氣過濾片。

使用鋒利物體（如牙籤）將舊空氣過濾片卸下，插入新的空氣過濾片。

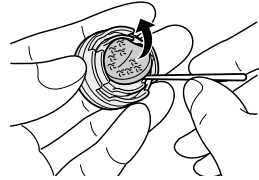

3. 重新裝上空氣過濾蓋。

**注：**

- 請僅使用此設備專用的 OMRON 空氣過濾片。切忌在沒有過濾片的情況下操作。
- 空氣過濾片無前後面之分。
- 插入前，請檢查空氣過濾片，確保其乾淨且無灰塵。
- 切勿試圖清洗過濾片。如果空氣過濾片變潮濕，請將其更換。因為潮濕的空氣過濾片可能引起阻塞。
- 要避免空氣過濾蓋的網孔阻塞，請定期清洗過濾片蓋。切勿開水煮沸空氣過濾蓋。取下空氣過濾蓋，清洗並晾乾，然後正確安裝。
- 若獲取備用空氣過濾片，或者如果隨設備提供的部件損壞或缺失時，請聯絡您的 OMRON 經銷商。

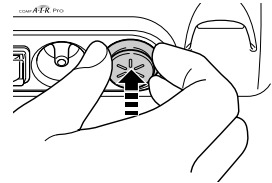

## 疑難排解注意事項

如果設備操作過程中出現故障，請檢查以下項目。您也可以參照本手冊中相關頁面，獲得詳細指導。

問題	原因	補救
按下電源開關後，無任何反應。	電源插頭是否正確插入電源插座？	檢查插頭，確保其已插入電源插座中。必要時，將插頭拔出，然後重新插入插座。
開啟電源後，無噴霧或噴霧效果差。	藥物杯中是否有藥劑？	往藥物杯中注入藥劑。
	藥物杯中的藥劑是否過多或太少？	往藥物杯中添加適量的藥劑。
	是否缺失折流板或未正確組裝？	正確連接折流板。
	噴霧杯是否組裝正確？	正確組裝噴霧杯。
	噴嘴是否阻塞？	確保噴嘴無阻塞。
	噴霧杯是否傾斜很厲害？	確保噴霧杯傾斜度不超過 45°。
	氣管是否連接正確？	確保氣管正確連接到壓縮機和噴霧杯上。
	氣管是否被折疊或損壞？	確保氣管未扭結。
	氣管是否阻塞？	確保氣管無阻塞。
空氣過濾片是否乾淨？	請更換新的空氣過濾片。	
設備運行時，出現不正常的噪音。	空氣過濾蓋是否連接正確？	正確連接空氣過濾蓋。
設備運行時，機身溫度很高。	通風槽是否阻塞？	切勿阻塞通風槽。

### 注：

- 如果建議的補救方法仍無法解決問題，切勿自行修理設備，因為設備內無用戶可維修的部件。請將設備退還給授權的 OMRON 經銷商。
- 設備每年應由經授權的 OMRON 服務中心檢修一次。

## 規格

型號：	NE-C29
類型：	非加熱壓縮機噴霧器
電源：	230V, 50Hz 型 ; 230V, 60Hz 型
電源消耗：	138VA
噴霧速率：	0.4 ml/min (無蓋)
粒子尺寸：	約 5 $\mu\text{m}$ (MMD)* (基於 EN13544-1 測量)
藥物箱容量：	7 ml (cc) 最大容量
適當的藥劑量：	2 - 7 ml (cc)
操作溫度/ 濕度：	+10°C 至 +40°C, 30% 至 85% RH
儲藏溫度/ 濕度：	-20°C 至 +60°C, 10% 至 95% RH
重量：	大約 2.3kg (只限壓縮機)
尺寸：	大約 186 (寬) x 180 (高) x 216 (深) mm
附件：	壓縮機、噴霧器、氣管、5 個備用空氣過濾片、口含配件、成人面罩、兒童面罩、使用說明書

\*MMD = 質量中位直徑

### 注：

- 若有任何技術修正，恕不另行通知。
- 請注意：規格視乎所使用藥劑類型的不同而有所差異。
- 使用設備時，請勿將其暴露於易燃性氣體下。
- 該設備符合 EMC (電磁兼容性) 標準 IEC60601-1-2:2001。  
但是，如果該設備與其他醫療設備或電氣設備一起使用，可能影響其中一種設備的操作效果。請遵循本手冊中的所有使用說明，正確使用所有設備。
- 这 OMRON 产品是在 OMRON HEALTHCARE Co., Ltd, 日本, 严格的质量体系下生产的。

 請仔細閱讀本說明書

CE 0197

## 任選部件及附件

### 噴霧杯全套部件

型號：C28NEBKIT

噴霧杯

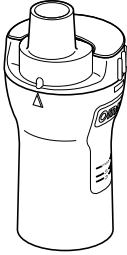

口含配件

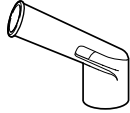

氣管

型號：C30TUBE

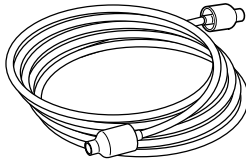

口含配件

型號：C28MP



鏡鼻

型號：C28NP



成人面罩

型號：C28AM

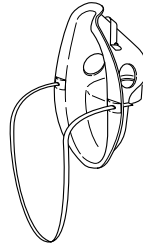

兒童面罩

型號：C28CM

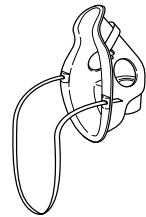

空氣過濾片(x5)

型號：C28FL

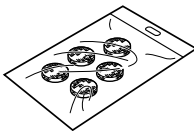

空氣過濾蓋

型號：C28FLCVR



# NOTES

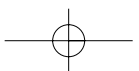
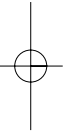
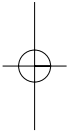

# OMRON

	<b>OMRON HEALTHCARE Co., Ltd.</b> 53, Kunotsubo, Terado-cho, Muko, Kyoto, 617-0002 JAPAN		
<table border="1"><tr><td>EC</td><td>REP</td></tr></table>	EC	REP	<b>OMRON HEALTHCARE EUROPE B.V.</b> Scorpius 33, 2132 LR Hoofddorp THE NETHERLANDS
EC	REP		
<b>Asia Pacific HQ</b>	<b>OMRON HEALTHCARE SINGAPORE PTE LTD.</b> 438A Alexandra Road, #05-05/08 Alexandra Technopark, Singapore 119967		
<b>Production facility</b>	<b>OMRON (DALIAN) CO., LTD.</b> Dalian, CHINA		